



Brix Lab
A Division of Brix Group, Inc.
541 Division St.
Campbell, CA 95008
866-787-1810
www.brixcom.com



User Guide SIR-STRPNP1

CONGRATULATIONS!

Your new Streamer™ portable Plug-n-Play from The Brix Group lets you enjoy SIRIUS® Satellite Radio's digital entertainment streams anywhere you've installed one of our SIR-STRHK1 Home Docking Kits or SIR-STRVK1 or SIR-STRVK2 Vehicle Docking Kits (sold separately). Use this manual to familiarize yourself with all of Streamer's features and capabilities.

For the latest information about this and other Streamer products, visit the Brix Web site at: www.brixcom.com

Table of Contents

Congratulations	2	Menu Display Options	23
Box Contents	3	Sirius ID.....	24
Safety Precautions	3	Display Settings.....	24
Installation in a Vehicle.....	6	FM Transmitter.....	24
Installation in a Home	10	Stream Add/Skip.....	25
Front Panel Controls and Features	12	Lock Options.....	25
Remote Control Functions.....	13	Audio Level.....	27
Activating your SIRIUS Subscription	14	Antenna Aiming.....	27
Removing Streamer from the Dock	14	Memory Options.....	27
Basic Operation	15	Time Based Features.....	28
Selecting Music.....	16	Factory Default.....	32
Direct Tuning.....	17	Troubleshooting Guide	33
Setting/ Tuning Stream Presets.....	17	Specifications	33
Display Button.....	19	Warranty.....	34
Memory Button/S-Seek Feature.....	20		

Box Contents

Unpack your Streamer carefully and make sure that everything listed here is present:

1 x STREAMER Main Unit

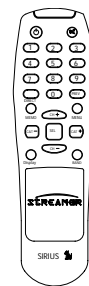

1 x Remote Control

2 x AAA batteries



If anything is missing or damaged, or if your Streamer fails to operate, notify your dealer immediately. If your Streamer was shipped to you directly, notify your shipper immediately. Streamer recommends that you retain the original carton and packing materials in case you need to ship your Streamer in the future.

Safety Precautions

Warning

Take the following precautions to prevent traffic accidents and avoid personal injury:

- Installation must be performed according to this installation manual. The Brix Group is not responsible for issues arising from installations not performed according to the procedures in this manual.

- Do not install the unit where it may obstruct your view through the windshield or of your vehicle's indicator displays.

- Do not install the unit where it may hinder the function of safety devices such as an airbag. Doing so may prevent the airbag from functioning properly in the event of an accident.

- The installation and use suggestions contained in this manual are subject to any restrictions or limitations that may be imposed by applicable law—the purchaser should check applicable law for any restrictions or limitations before installing and/or operating this unit.

- Failure to follow these safety instructions and warnings may result in a serious accident.



Warning

Take the following precautions to prevent fire and avoid personal injury:

- To avoid short circuits, never put or leave any metallic objects (coins, tools, etc.) inside the unit.
- If the unit emits smoke or strange smells, turn the power off immediately and consult your Brix Group dealer.
- Do not drop the unit or subject it to strong shocks.
- If the LCD display becomes damaged or broken, do not touch the liquid crystal fluid. The fluid may be dangerous to your health or even fatal. If the liquid crystal fluid contacts your body or clothing, immediately wash it off with soap and water.



Caution

Take the following precautions to keep the unit in proper working order:

- Be sure the unit is connected to a 12V DC power supply with a negative ground connection.
- Do not open the unit.

- When replacing a fuse, use only a new one with the proper rating. Using a fuse with the wrong rating may cause the unit to malfunction.
- To prevent a short circuit when replacing a fuse, first disconnect the wiring harness.
- When drilling holes to mount the unit, make sure not to damage wiring or other systems on the other side.

Note

If the unit doesn't seem to be working properly:

- Turn the unit's power off, wait 5 – 10 seconds, then turn the power on again.
- If the unit still mis-operates, turn the unit's power off, remove it from the cradle, wait 5 – 10 seconds, replace it in the cradle and turn the power back on. If the problem persists, consult your Streamer dealer.

FCC Warning

This equipment may generate or use radio frequency energy. Changes or modifications to this equipment may cause harmful interference unless the modifications are expressly approved in this

User Guide. The user could lose the authority to operate this equipment if an unauthorized change or modification is made.

Note

This equipment has been tested and found to comply with Part 15 of the FCC Rules. These rules are designed to provide reasonable protection against harmful interference in a residential installation. This equipment may cause harmful interference to radio communications if it is not installed and used in accordance with these instructions. However, there is no guarantee that interference will not occur in a particular installation. If this equipment does cause harmful interference to radio or television reception, which can be determined by turning the equipment off and on, the user is encouraged to try to correct the interference by one of more of the following measures:

- Reorient or relocate the receiving antenna.
- Increase the separation between the equipment and receiver.

Connect the equipment into an outlet on a circuit different from that to which the receiver is connected

- Consult the dealer or an experienced radio/TV technician for help.

Cleaning the Unit

If the unit becomes dirty, turn its power off and wipe it clean with a soft dry cloth. Do not use hard cloths or paint thinner, alcohol, or other volatile solvents to clean the unit. These may cause damage or remove indicator characters.



Warning

Do not operate the unit in a way that might divert your attention from driving safely. As a driver, you alone are responsible for safely operating your vehicle in accordance with traffic safety laws at all times.

Vehicle Docking Kit Installation Guide for SIR-STRVK1 or SIR-STRVK2 Kit (sold separately)

Note: Do not put Streamer in the docking station until you have completed the installation.

SIR-STRVK1 Contents:

- Installation Guide.
- Vehicle docking cradle with wireless FM transmitter.
- Suction Cup Mount.
- Heavy-duty antenna mount (not shown).
- Cigarette lighter power supply.
- Magnetic roof-mount SIRIUS antenna.

SIR-STRVK2 Contents:

- Installation Guide.
- Vehicle docking cradle.
- Base mount.
- Cassette adapter.
- Cigarette lighter power supply.
- Audio cable.
- Magnetic roof-mount SIRIUS antenna.

Note: The SIR-STRVK1 Kit doesn't come with the shown cassette adapter because it has a wireless FM Transmitter.

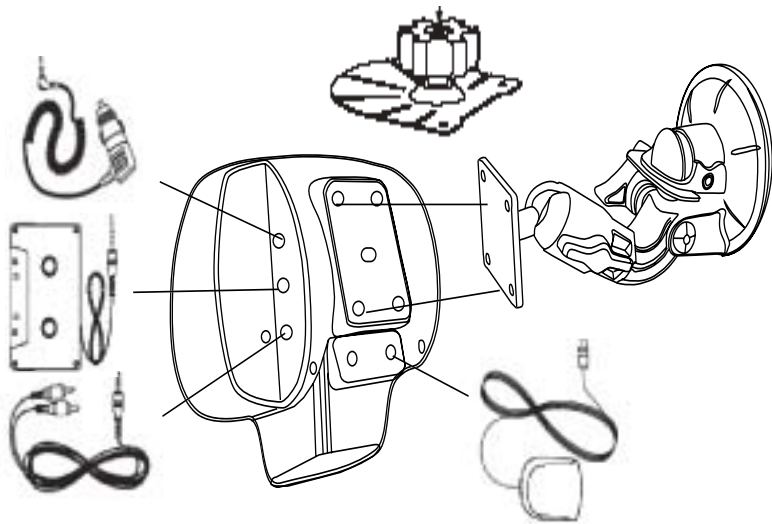

Installation in a Vehicle (continued)

1. Determine where you want to mount Streamer.
 - Do not install Streamer where it may obstruct your view through the windshield or your view of your vehicle's indicator displays.
 - Do not install Streamer where it will hinder your access to the vehicle's controls.
 - Do not install Streamer where it may hinder the function of safety devices such as an airbag. Doing so may prevent the air-bag from functioning properly in the event of an accident.
 - Find a location that provides good visibility of and access to Streamer's front panel.
 - The Brix Group strongly recommends that you mount

2. You can bend the leaves on the base to conform to curved mounting surfaces.
3. Peel the covering away from the adhesive on the bottom of the base and adhere it to the mounting surface. Use the provided screws to securely attach the base to the surface.
 - If using screws, be sure that you do not damage wiring or other systems on the other side of the mounting surface.
4. Using the provided screws, assemble the docking station

Streamer in a location where the base can be attached with the provided screws or on the windshield with the provided suction-cup mount..

5. Plug the cigarette lighter adapter into the back of the cradle. Don't plug the adapter into the cigarette lighter until the installation is completed.
- 6A. Plug the cassette adapter into the back of the cradle (SIRSTRVK2 kit only). For the SIR-STRVK1 kit, tune your radio to one of four FM stations on the side of the vehicle dock
- 6B. If your car stereo has an aux input, plug the supplied audio cable into the back of the cradle instead of the cassette adapter. Plug the audio cable's white (L ch.) and red (R ch.) connectors into your car stereo.

Installation in a Vehicle: Mounting the Antenna

1. Temporarily plug the antenna into the “1-Sat/Terr (Main)” connector on the back of the cradle until it is firmly seated.

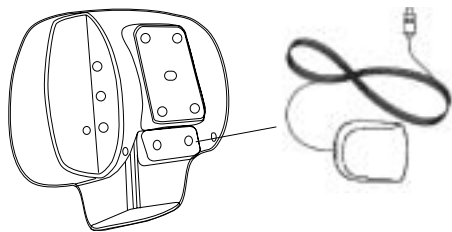

2. Find an antenna location on a metal surface of your vehicle at least 12" x 12", and at least 6" from a window. If you use the included antenna mount (SIR-STRVK1 only), install the mount on the upper portion of your side-view mirror bracket.

- Best reception is achieved with the antenna mounted on the roof or trunk for convertibles.
 - If the vehicle has a roof rack or skid ribs, it may be necessary to mount the antenna off-center.
3. The antenna's powerful magnet will secure it to the metal surface. Before routing the antenna cable, confirm that the antenna is mounted in a good location:
4. Temporarily plug the cigarette lighter adapter into the cigarette lighter.
5. Slide Streamer all the way into the cradle so that the connector at the bottom of the unit makes proper contact in the cradle. Press and hold the POWER button to turn Streamer on.
6. If your Streamer has been properly connected and the antenna is receiving the SIRIUS signal you will hear audio. If you do not hear audio, the display will read “Antenna Error”. Re-orient the antenna until you hear audio. (See Antenna Signal, on page 27 to use the ANTENNA SIGNAL screen to aim the antenna.)
- Make sure the vehicle is not in garage, or somewhere the satellite signal could be blocked.

Installation in a Vehicle: Running the Antenna Cable

1. Turn Streamer's power off and remove it from the cradle; unplug the cigarette lighter adapter from the cigarette lighter; unplug the antenna from the cradle.
2. Route the cable from the antenna to the vehicle's interior by tucking it underneath the rubber molding around rear window, as shown below.



3. Route the cable from the lowest point of the rear window into the trunk. Take advantage of any existing cable channels or wiring conduits.

- For SUVs, minvans & 5-door vehicles, bring the cable into the vehicle under the rubber molding for the tailgate, and continue under the interior trim.

4. From the trunk, route the cable around the passenger compartment and to the back of the cradle.
- Do not pull the wire across sharp edges that could damage it.
 - Keep the wire away from areas where it could become tangled in driver's and passenger's feet.

5. Plug the antenna into the back of cradle where it says “ANT”.

6. Plug the cigarette lighter adapter into the cigarette lighter. **THE BRIX GROUP RECOMMENDS UNPLUGGING THE CIGARETTE LIGHTER ADAPTER AFTER YOU TURN THE VEHICLE'S IGNITION OFF.**

Installation in a home with the SIR-STRHK1 kit (sold separately)

Note: Do not put Streamer in the docking station until you have completed the installation.

1. Plug the audio cable's mini connector into the back of the cradle, as shown. Plug the audio cable's white (L ch.) and red (R ch.) connectors into your audio system.

2. Plug the AC cord into the power supply, then plug the power supply into the back of the cradle, as shown. Don't plug the AC cord into a wall outlet until the installation is completed.

3. Plug the antenna into the back of the cradle until it is firmly secure.

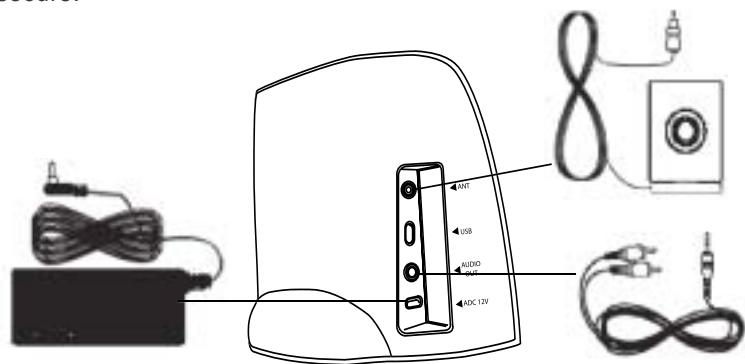

Installation in a home (continued)

4. Due to the paths of SIRIUS satellites over the US, the best location for the antenna in your home depends on where you live. Use the map below as a general placement guideline—some experimentation may be needed to obtain the best results. In major US cities, you may also be able to receive the signal from SIRIUS ground repeaters, which may allow you to place the antenna away from a window. In all cases, since the antenna is weather-proof if necessary you can also locate it outside, clear of any overhead obstructions. (This is especially important if your house has an extended roof or extended window frame structures.) See page 30 for more information about using the ANTENNA SIGNAL screen to aim the antenna.

Section 1: Place the antenna at an EAST-FACING window

Section 2: Place the antenna OUTSIDE, away from any overhead obstructions

Section 3: Place the antenna at a WEST-FACING window

Section 4: Place the antenna at a NORTH- or EAST-FACING window

Section 5: Place the antenna at a NORTH-FACING window

Section 6: Place the antenna at a WEST- or NORTH-FACING window



Streamer Controls and Features

POWER Button : Turns Streamer On and Off; exits the Stream, Category, Song & Artist List modes.

Encoder Knob & Select Button: Navigates through display screens and makes selections of items highlighted on the display. (CW) Clockwise-increases or moves up in the menus. (CCW) decreases or moves down in the menus.

CATEGORY Up/ Down Button: Navigates through Category List Screen which displays Sirius Stream Categories.

Display (DISP) Button: Changes text size of artist names and song titles.

Menu Button: Used to access menu options to make set-up and feature changes.



Preset Number Buttons (0-9): Sets and selects preset streams.

Memory (MEMO) Button (S-Seek Function): Saves and recalls artist names and song titles. You can store up to 20 artist/song title combinations.

Band Button (P.Tune): Pressing and releasing switches between preset banks A, B, and C, which hold 10 presets each. Pressing and holding enables "Preset Tune Mode", which allows for viewing and listening of stored presets with turn of navigation wheel.

Remote Control Receiver: Receives signals from the included wireless remote control.

Remote Control Functions

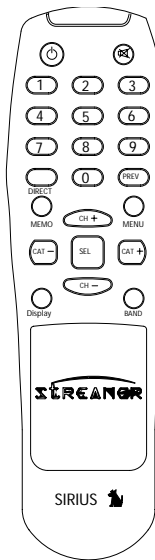

POWER Button : Turns Streamer on and off.

CH+/ CH-/ CAT+/ CAT- Buttons: Navigate through streams, categories, and display screens.

Mute Button: Mutes audio.

PREVIOUS (PREV) Button: Navigates back to previous stream.

DIRECT Button: Accesses streams directly by number.

SELECT (SEL) Button: Press to select items highlighted on the display; hold-down to jump to the previously-received Stream.

MENU Button: Enters and exits the Setup Mode.

MEMORY (MEMO) Button: Saves & recalls song & artist information; sets Parental Lock code number.

DISPLAY Button: Changes text size of artist names and song titles.

BAND Button: Switches between preset bands A, B, and C.

Number Buttons (0-9): Selects streams directly and by preset.

Installing Batteries in the Remote

1. Remove the battery cover.
2. Install two AAA batteries.
3. Replace the battery cover.

Activating your SIRIUS Subscription

Before you can listen to Streamer, you must subscribe to SIRIUS Satellite Radio's service.

1. Make sure that Streamer is properly connected and that its antenna is oriented to receive the SIRIUS satellite signal (see *Installation* sections for details).
2. Press the power button to turn Streamer on. After displaying the SIRIUS logo, Streamer will update all Sirius channels. The display will read "UPDATING STREAMS" on the top line and "X% Completed" (0%-20%-40%-60%-80%-100%) on the bottom line shall be displayed by the Streamer until the update completes. **NOTE: Don't push any buttons or perform any operations until updating has been completed.** Once all updated SIRIUS channel streams are received, the display will change to "Call 1-888-539-SIRIUS to Subscribe" and will place you in SIRIUS Satellite Radio's Preview Channel. Channel 184 is the SIRIUS preview channel. You will not be able to tune to any other channels until you activate your SIRIUS subscription.

4. Hit the MENU button to enter the Setup Mode.
5. Turn the Encoder Knob left (counter-clockwise) until "Sirius ID" is highlighted. Push on the Encoder Knob to select "Sirius ID". This will display your unit's unique 12-digit SIRIUS ID Number. This SID number should also be available on the Streamer packaging. Write the number down and have your credit card handy.



6. Contact SIRIUS on the Internet at: <https://activate.siriusradio.com/> Follow the prompts to activate your subscription.
 - You can also call SIRIUS toll-free at 1-888-539-SIRIUS (7474). The operator will instruct you.

Removing Streamer from the Dock

To remove Streamer from the docking station, press the button on the underside of the unit and gently slide Streamer out of the cradle. Replace it by sliding the unit all the way into the cradle so that the connector at the rear of the unit makes proper contact in the cradle.

Basic Operation

After you have successfully activated your SIRIUS subscription, the Normal Operation screen will appear (*bottom, right*): Use the Encoder Knob select streams.

- The selected stream will automatically play the name and artist of the currently-playing song and will scroll across the display. If you want to listen to a different entertainment category, push the CATEGORY button up or down to activate the Category Select screen (*top, right*):

1. Use the CATEGORY button to scroll through music and entertainment categories.
2. When the category (ex. Rock) you want is highlighted, use the Encoder Knob to highlight the stream you want to hear.
3. When the stream you want is highlighted, press the Encoder Knob to listen to the stream. The display will revert to the Normal Operation screen for that stream. (*bottom, right*)
4. If you decide not to select another stream, press and release the POWER button to exit the mode. The display will revert to the Normal Operation screen for the active stream.

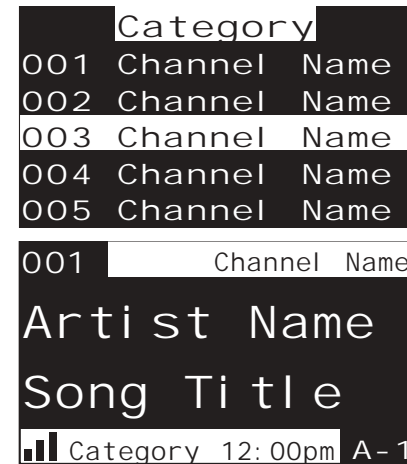

Selecting Music

In addition to the Normal Operation and Category Select screens, STREAMER has three ways to search for and select music: by stream, by artist, and by song.

Selecting Music by Stream (Stream List Mode)

1. Press and hold the DISPLAY (DISP) button for two seconds while in the Normal Operation mode. The Stream List screen will appear, showing all available streams regardless of category. (*below*):

```
001 Channel Name
002 Channel Name
003 Channel Name
004 Channel Name
005 Channel Name
006 Channel Name
```

2. Use the up & down arrow buttons to move through the streams. If you stop on a stream it will play.

Selecting Music by Artist (Artist List Mode)

1. While the Normal Operation screen is active, press the DISPLAY (DISP) button twice. The Artist List screen will appear, showing all currently-playing artists regardless of category (*below*):

- If composer information is available for a stream, it will be displayed along with the artist information

```
001 Artist Name
002 Artist Name
003 Artist Name
004 Artist Name
005 Artist Name
006 Artist Name
```

Selecting Music by Song Title (Song Title List Mode)

1. While the Normal Operation screen is active, press the DISPLAY (DISP) button three times. The Song Title List screen will appear, showing all currently-playing songs regardless of category (*below*):

```
001 Song Title
002 Song Title
003 Song Title
004 Song Title
005 Song Title
006 Song Title
```

2. Use the Encoder Knob to move through the list of artists.

3. When the artist you want to hear is highlighted, press the Encoder Knob to listen to them.

Direct Tuning

Streams can also be directly accessed by pressing the Encoder Knob and using the 0-9 number keys to numerically enter the desired stream. Once the desired stream number has been entered, press the Encoder Knob again to play the desired stream.



Setting Stream Presets

You can store up to 30 of your favorite streams as presets, for quick access. Presets are stored in 3 banks, A, B, & C, each containing 10 stream presets.

1. Press the BAND button to activate the preset bank you want. The selected bank is shown in the lower left corner of the Default.
2. Select the stream you want to preset (see *Basic Operation* and *Selecting Music*)
3. Hold the number button you want to store the stream in for at least 2 seconds.

- The selected preset number will flash and then remain lit on the display to show that it has been memorized.
- If the preset button already has a stream stored in it, it will be replaced with the new stream.

Tuning Stream Presets

The 6 presets in the active bank can be selected by pressing the “0” – “9” buttons.

2. When the desired preset bank is displayed, use the “0” – “9” buttons to tune the desired preset stream.

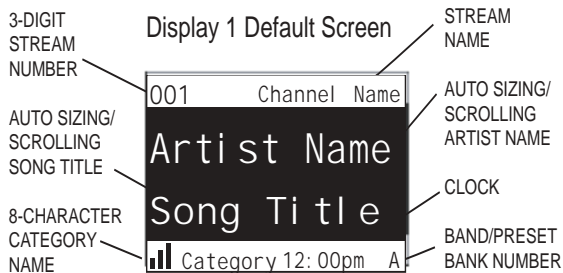

Searching for a Stream Preset

To search by list for a preset, press and hold the BAND button to enter Preset Tune Mode (P.TUNE). While the contents of the preset listing is displayed, rotate the Navigation Wheel to navigate through the list. When the desired selection is highlighted, press the Navigation Wheel and the stream will be played.

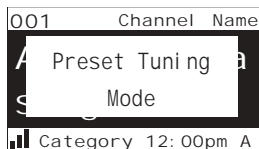

Preset Tune Mode

When in the P.Tune Mode, press and hold the DISP button for 2 seconds; this exits normal preset tuning and enters a 6-line menu mode which displays the Preset number (A-1), a single space and the 20-character stream name. While in the Preset List menu, pressing the DISP button once will change to Artist List; a second press of the DISP button changes to Song Title List. (next page, top)

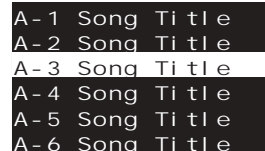
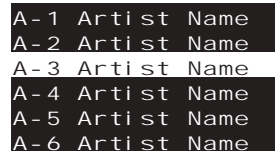

NOTE: The field will scroll only if the length of the artist or title cannot be viewed in its entirety. Pressing and holding the Display button will enter the stream list mode.

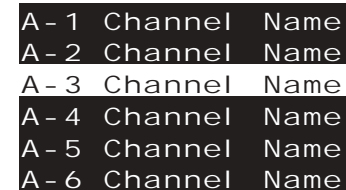
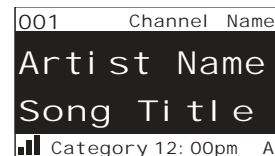

Display Button

Pressing the DISP button from the Default display toggles between the artist name, song title fields and large character size. In doing so, this will change the character size and cause the field to scroll. This feature is useful when viewing the display at a distance.

While in the Stream List mode, any subsequent press of the DISP button will display program information by Artist Name or Song Title. Pressing and holding the DISP button will exit the Stream List mode and return to the previously selected tuning/display mode.

Memory Button (S-Seek Function):

This feature allows the user to capture and store the current program definition text- PDT (Artist & Song title) with a total of 20 listings(20 Artist/Song Title combinations). The unit also has the capability to search the current incoming Sirius signal and alert the user when a saved song is being played.

1. While the Shuttle is in either of the two standard display modes, momentarily pressing and releasing the MEMO button stores the current program data information within the Shuttle's memory. A Memory Stored pop-up screen, followed by "X Used / Y Empty" will each appear for 1 second.

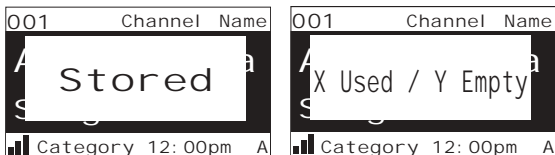

2. By holding down the MEMO button for 3 seconds, the stored memory information (one at a time) is displayed on the LCD screen in page format. Use the Encoder knob to scroll through the 20-page listing and view the information. This function allows you to recall information regarding the Artist/Song Title for your own personal review.



3. Momentarily pressing the Encoder Knob while in memory recall mode results in a pop-up screen displaying two selectable options:

Delete
S-Seek



Turning the Encoder Knob highlights the options and pushing the Encoder Knob selects the option. The **S-Seek** option implies S-Seek On/Off, with the default setting as S-Seek On.

4. Each time the Streamer is turned on, it automatically searches the incoming signal to determine if a match exists between the signal and the currently saved information stored in receiver memory. If one or more matches are found, a pop-up screen momentarily appears for 2 seconds and displays the Phrase **S-Seek Alert**. An audible beep tone will be heard indicating that a match has been found.

The display then reverts to the S-Seek Alert screen which displays the current matches. You can now select the Artist/Song Title that you wish to listen to.

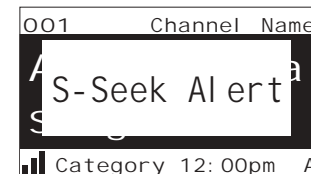

No stored match alert is provided for the currently selected stream. To ensure that no duplicate entries are stored in memory, the receiver will check the stored input data to ensure the information about to be stored is not already in memory.

a. If one or more matches are found, a display list appears, and allows you to scroll through the list of songs using the Encoder Knob. Once a song is found, it can be selected by pressing the Encoder Knob, and the display will revert to either of the selected display modes.

b. If a selection is not chosen within 10 seconds after the last action, the screen will revert to the previously selected display and tuning mode.

NOTE: 1. Play of the current selection will continue until a new selection is made.

5. If the MEMO button is pressed to save a selection currently playing, and all of the memory spaces are full, a prompt screen alerts you to the possibility of accidentally overwriting a memory space with new information.

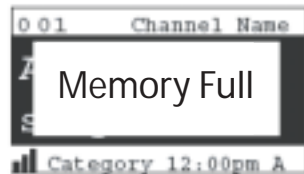

If the MEMO button is pressed to save a currently playing selection, and all of the memory spaces are full, **S-Seek Full** will flash on the display for 1 second, followed by a pop-up screen presenting the **Replace-Cancel** options. This prompt allows you to make the following Replace/Cancel choices: (Next Page)

a. By selecting **Replace**, the memory list will appear, and you can use the Encoder Knob to select the information that you would like to overwrite with the new Artist/Song Title. After highlighting the selected title in the list, press the Encoder Knob to delete the stored Artist/Song Title, and replace it with the updated information.

b. By selecting **Cancel**, the prompt screen would disappear and revert to the original screen.

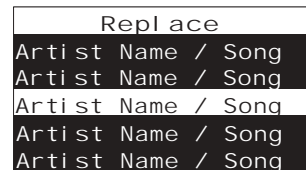

Menu Display Options

To enter the Menu Options page, press and hold the MENU Button for 3 seconds. The **Menu Options** list will appear on the LCD display.

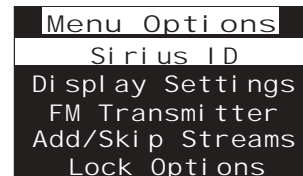

Using the Navigation Wheel, highlight the option you wish to adjust and press the Navigation Wheel. The following options are available:

- | | |
|-------------------------|-------------------------------|
| Sirius ID | Audio Level |
| Display Settings | Antenna Aiming |
| FM Transmitter | Options Memory Options |
| Add or Skip | Time Based Features |
| Lock Options | Factory Default |

If, while in the menu screen function, a button is not pressed within 10 seconds from the previously selected function, the unit exits the menu screen function and reverts to the default screen display.

Sirius ID

Displays your 12 digit Sirius ID number. No adjustments are allowed in this mode. To exit this option, press the Encoder Knob or Menu Button.

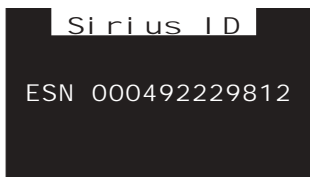

Display Settings

The following adjustments are possible:

Dimming Control

Contrast Control

To enter either of these modes, use the Encoder Knob to highlight the option you wish to adjust and then press the Encoder Knob. Upon entering either of these modes, a 10 segment horizontal bar graph is displayed with a “-” sign to the left and a “+” sign to the right.

The current setting is indicated on the bar graph. Rotating the Encoder Knob adjusts the bar graph indication and function accordingly. To select and exit this function, press the Encoder Knob. (No button activity for 10 seconds will also exit this function.)

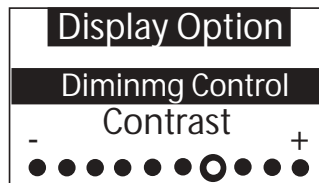

FM Transmitter Options

The following adjustments are possible:

FM On/ Off

Upon entering this mode, rotating the Encoder Knob toggles between the FM ON or FM OFF function/display selection. To select and exit this function, press the Encoder Knob. (No button activity for 10 seconds will also exit this function.)

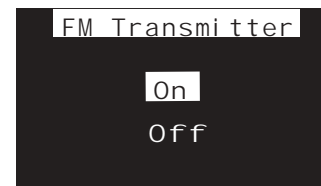

Stream Add/ Skip

Upon entering this mode, a stream list shall be displayed with the current stream in play highlighted. Rotate the Encoder Knob to navigate the list and highlight the stream to be adjusted. Once a stream has been highlighted, pressing the Encoder Knob displays the text “Skip” next to the stream, and prevents the stream from being accessible during any of the tuning modes. Skipped streams can only be accessed either through direct stream number entry or by returning to this menu and going through the same process to return the skipped stream to the list. Adding a stream will remove the text “Skip” from alongside the stream number/ name.

Lock Options

Upon entering this mode for the first time, the user is prompted to enter the four digit numerical code that is used to lock/unlock stream access. All future entries into this mode displays a stream list with the current stream in play highlighted. The Encoder Knob Wheel is used to navigate the list and highlight the stream to be adjusted. Once a stream has been highlighted, pressing the Select Button displays the text “Lock” next to the stream and prevents the stream from being accessible during any of the tuning modes. Locked streams can be accessed only by direct stream number entry, at which time the user will be prompted to enter the previously stored 4-digit code. Once the correct code has been entered, the audio begins to play. The stream returns to the locked status if the stream is changed or the vehicle/unit is turned off (or by returning to this menu).

Upon adding a stream, the text “**Lock**” is removed from alongside the stream number/name.



Lock/Unlock Default Code Function

The first time the Lock/Unlock function is accessed, the user must enter the default lock code. The default lock code is “0000”. This code can be maintained or changed. To change the default lock code perform the following procedure:

1. Press and hold the MODE button to access the User Menu.
2. Rotate the Encoder Knob to select the “**Lock Options**”.
3. Press the Encoder Knob.
4. Rotate the Encoder Knob to highlight “**Edit Code**”.

5. Press the Encoder Knob.
6. Enter the default code “**0000**”.
7. The “**New Code**” prompt will appear. Enter your new four digit code using the 0-9 number buttons. You will then be prompted to confirm the new code by entering your code again.
8. The lock code is now changed.

Edit Code

Upon entering this mode, the user is prompted to enter the current four digit numerical code being used to lock/unlock stream access. Once the correct code has been entered, the user is prompted to enter the new 4-digit code twice. The second entry is requested for confirmation.

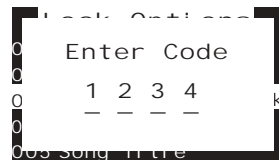
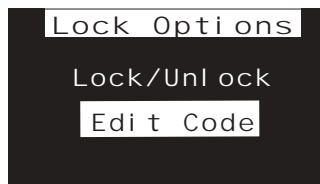

Audio Level

Upon entering this mode, a 10 segment horizontal bar graph is displayed with a “-” sign to the left and a “+” sign to the right. The current setting is indicated on the bar graph. Rotating the Encoder Knob will adjust the bar graph audio level indication and audio gain, accordingly. To select and exit this function, press the Encoder Knob. No button activity for 10 seconds will also exit this function.

Antenna Aiming

Upon entering this mode, a 10 segment horizontal bar graph is displayed with a “-” sign to the left and a “+” sign to the right. The current setting is indicated on the bar graph. Moving the antenna location adjusts the bar graph signal strength indication, thus ensuring optimum reception. To exit this function, press the Select Button.

Antenna Aiming

Memory Options

In this mode, the user can turn the Memory Search Function (S-Seek) ON or OFF. In addition, all 10 Memory Locations can be cleared. On the display, the top line displays the text **Memory Options**.

The following adjustment options are possible:

1. Automatic Memory Search function - On or Off. Use the Encoder Knob to select between the 2 options by highlighting the desired selection. Then press the Encoder Knob to enter the option.

2. Clear all Memory Locations. Momentarily press the Encoder Knob; a prompt display screen appears confirming - **Are You Sure?** Select “Yes” or “No” and press the Encoder Knob.

Time Based Features

The following adjustments are possible:

- Clock**
- Alarm Clock**
- Program Alert**
- Auto Shutdown**
- Sleep Mode**

Upon entering this mode, rotate the Encoder Knob to highlight the desired function and press the Encoder Knob.

NOTE: No button activity for 10 seconds will also exit the desired (highlighted) function.

Clock

When entering this menu option, you can set up the clock shown on the default display, based on the format desired, and the time zone in which you reside. The clock data is provided via the Sirius Satellite stream, and will update based on the received signal.

Format:

The clock format option provides:

12 Hour (Default)

24 Hour

Use the Encoder Knob to highlight the desired format and press the Encoder Knob.

Time Zone:

The Time Zone option provides:

(GMT-9:00) Alaska

(GMT-8:00) Pacific

(GMT-7:00) Mountain

(GMT-6:00) Central

(GMT-5:00) Eastern

(GMT-4:00) Atlantic

(GMT-3:30) Newfoundland (Abbreviated as

(GMT-3:30 Newfndlnd)

Use the Encoder Knob highlight the desired time zone and press the Encoder Knob.

Daylight Savings Time (DST) Observance:

Activate this function if your area is subject to DST; Turn the Navigation Wheel to toggle between **DST Observed** (default) or **DST Not Observed**.

Alarm Clock:

When this menu option is highlighted and selected, you will be able to set the unit to turn on at a specific time. The last selected stream prior to shutdown will be present when the Alarm feature is activated. Alarm appears on the first line of the display followed by the alarm options:

Set Alarm (Default-Off)

Use the Encoder Knob to toggle between **Alarm On** or **Alarm Off** and press the Encoder Knob for desired alarm status.

Time (Default-12:00pm)

Use the Encoder Knob to increase (Clockwise) or decrease (Counter Clockwise) the alarm set time in a circular motion on one line in the middle of the display from the default value (12:00pm). AM or PM will switch automatically when the AM or PM threshold has been exceeded. When the desired time is displayed, press the Encoder Knob.

Program Alert:

When this menu option is highlighted and selected, you will be able to program the unit to switch to a selected stream at a specific time. On the display, **Set Stream Alert** will occupy the top text line.

The following adjustments are accessible:

Time/Day (Default-12:00pm, Monday)

Stream (Default-Currently Playing Stream)

Program Alert On/Off (Default-Off)

Time/Day:

Rotating the Encoder Knob toggles between **Time** and **Day**. If **Time** is selected, use the Navigation Wheel increase (CW) or decrease (CCW) the set time in a circular motion on one line in the middle of the display from the default value (12:00pm).

AM or **PM** will switch automatically when the AM or PM threshold has been exceeded. When the desired time is displayed, press the Navigation Wheel.

If **Day** is selected, the screen displays a default day of **Monday**, with selectable choices of **Monday, Tuesday, Wednesday, Thursday, Friday, Saturday** or **Sunday**. Use the Encoder Knob to increase (CW) or decrease (CCW) the desired day in a circular motion on one line in the middle of the display from the default value (Monday).

Stream:

Rotate the Encoder Knob to scroll through a listing of all the Sirius streams in a circular motion. The listing should encompass all 6 available lines. When the desired stream is highlighted, press the Encoder Knob.

Program Alert On/Off:

Rotate the Navigation Wheel to toggle between **Program Alert On** or **Program Alert Off**. When the desired alert status is highlighted, press the Navigation Wheel.

Auto Shutdown:

In this mode, you have the option of programming the unit to automatically shut off after a 1-hour period without any user intervention. After 59 minutes of inactivity, a beep tone sounds, and a display prompt appears on the screen, stating

Cancel Auto Shutdown.

Press the Navigation Wheel to terminate the function temporarily.

The following options are available in this mode:

Enabled

Disabled (Default)

Rotate the Encoder Knob to toggle between **Enabled** and **Disabled**. When the desired shut down status is highlighted, press the Encoder Knob.

Sleep Mode:

In this mode, you have the capability of programming the unit to shutdown after a selected period of time. The screen displays Sleep Mode on the top line, with optional time settings as follows:

Off

15 min

30 min

45 min

60 min

Rotate the Encoder Knob Wheel to toggle through the desired sleep times. When the desired time is highlighted, press the Encoder Knob. The unit will now turn off after the selected time has expired.

Factory Default

The Factory Default screen displays the text **Restore Default Settings** with the following adjustments: **Yes/No**

Upon entering this mode, rotating the Encoder Knob toggles between the “Yes” or “No” function/display selection. If “Yes” is chosen, the unit reverts to the original factory settings for the following parameters:

- All Presets revert to empty
- Auto Dimming On
- Display Contrast to 50%
- Display Mode to Auto

- FM Modulator to On
- Audio Output Level to 50%
- Access to all skipped Shuttles (Locked streams remain locked)
- Memory Search On
- Memory Locations are erased
- 12 Hour Clock Format
- Eastern Time Zone
- Daylight Savings Time Observed

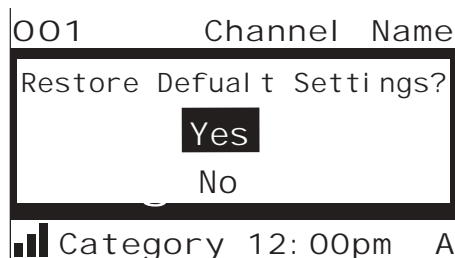

Troubleshooting

FAULT	PROBABLE CAUSE	REMEDY
Streamer does not turn on	Blown fuse, power cable not properly connected	Check fuse check power cable
Check antenna display message	Satellite antenna not connected	Check satellite connection to shuttle
	Antenna or cable is faulty	Contact system installer or vendor
Audio static or loss of clarity	FM modulator frequency contains static	switch to another FM frequency
	Vehicle antenna not connected to radio	Check vehicle antenna cable
No signal on shuttle display	Check for obstacles over or around antenna	Change location to eliminate nearby obstacles (bridge, etc.)
No sound	1. Audio Cables not connected 2. Incorrect FM modulator frequency	1. Check cables at Shuttle and radio 2. Select another FM modulator frequency.

Specifications

Audio Output 650mV RMS Maximum (100-250 ohms)

Fuse 3A Slow Blow

Power Supply 10-16V, Negative Ground, DC

Dimensions 138mm W x 92mm H x 48mm D (5 3/8" W x 3 5/8" H x 1 7/8" D)



12 MONTH LIMITED WARRANTY

The Brix Group (the Company) warrants to the original retail purchaser of this product that should this product or any part thereof, under normal use and conditions, be proven defective in material or workmanship within 12 months from the date of original purchase, such defect(s) will be repaired or replaced with new or reconditioned product (at the Company's option) without charge for parts and repair labor. To obtain repair or replacement within the terms of this Warranty, the product is to be delivered with proof of warranty coverage (e.g. dated bill of sale), specification of defect(s), transportation prepaid, to an approved warranty station or the Company at the address shown below.

This Warranty does not extend to the elimination of externally generated static or noise, to correction of antenna problems, to costs incurred for installation, removal or reinstallation of the product, or to damage to tapes, compact discs, speakers, accessories, or vehicle electrical systems.

This Warranty does not apply to any product or part thereof which, in the opinion of the Company, has suffered or been damaged through alteration, improper installation, mishandling, misuse, neglect, accident, or by removal or defacement of the factory serial number/bar code label(s). THE EXTENT OF THE COMPANY'S LIABILITY UNDER THIS WARRANTY IS LIMITED TO THE REPAIR OR REPLACEMENT PROVIDED ABOVE AND, IN NO EVENT, SHALL THE COMPANY'S LIABILITY EXCEED THE PURCHASE PRICE PAID BY PURCHASER FOR THE PRODUCT.

This Warranty is in lieu of all other express warranties or liabilities. ANY IMPLIED WARRANTIES, INCLUDING ANY IMPLIED WARRANTY OF MERCHANTABILITY, SHALL BE LIMITED TO THE DURATION OF THIS WRITTEN WARRANTY. ANY ACTION FOR BREACH OF ANY WARRANTY HEREUNDER INCLUDING ANY IMPLIED WARRANTY OF MERCHANTABILITY MUST BE BROUGHT WITHIN A PERIOD OF 48 MONTHS FROM DATE OF ORIGINAL PURCHASE. IN NO CASE SHALL THE COMPANY BE LIABLE FOR ANY CONSEQUENTIAL OR INCIDENTAL DAMAGES FOR BREACH OF THIS OR ANY OTHER WARRANTY, EXPRESS OR IMPLIED, WHATSOEVER. No person or representative is authorized to assume for the Company any liability other than expressed herein in connection with the sale of this product. Some states do not allow limitations on how long an implied warranty lasts or the exclusion or limitation of incidental or consequential damage so the above limitations or exclusions may not apply to you. This Warranty gives you specific legal rights and you may also have other rights which vary from state to state.

U.S.A. : Brix Lab A Division of Brix Group, Inc. 541 Division St. Campbell, CA 95008 866-787-1810 www.brixcom.com

