

TERK[®]



TRK-SR2 **Roof-Mount Satellite Radio Antenna** *Installation Guide*



TABLE OF CONTENTS

About Installation	2
Introduction	3
Applications	4
Four-Door Sedans	4
SUVs	4
Two-Door Coupes/Hatchbacks	4
Convertibles	5
Vans/Minivans	5
Pickup Trucks	5
Installation	6
TRK-SR2 Parts	6
Recommended Tools And Supplies	6
Installation Precautions And Tips	6
Installing The TRK-SR2	7
Use And Care	10
Troubleshooting	10
Specifications	11
Limited Warranty	12
About XM Satellite Radio	12

ABOUT INSTALLATION

Installation of automotive stereo components can require extensive experience with a variety of mechanical and electrical procedures. Although the instructions in this guide explain how to install the Terk TRK-SR2 Roof-Mount Satellite Radio Antenna in a general sense, they do not show the exact installation methods for your particular vehicle.

IMPORTANT: If you are not comfortable performing a complex installation, ask your local mobile audio dealer about professional installation options.

TRK-SR2 INSTALLATION GUIDE

INTRODUCTION

The Terk TRK-SR2 Roof-Mount Satellite Radio Antenna is a high-performance antenna designed specifically for XM Satellite Radio reception. It has dual-mode functionality, receiving simultaneous signals from satellites and terrestrial repeaters, to ensure continuous reception. The result is an antenna that offers all the benefits of satellite radio and complements the appearance of any vehicle. Its features include:

- Low-profile roof-mounted design
- Mounts to roof of vehicle via special acrylic foam adhesive pads that provide years of worry-free enjoyment, yet are removable if necessary
- Attached micro cables are designed to wrap around the rear window and to fold under rubber molding for an invisible wiring solution
- Tested and proven to Automotive Environmental Standards
- Shock- and vibration-proof design
- Safe for low-clearance conditions, including car washes

The TRK-SR2 is easy to install on most vehicles. The package includes all the necessary mounting hardware, as well as color-coded cable connectors to ensure complete compatibility with all XM receivers. Remember to save your sales receipt and this guide so both are available for future reference.

NOTE: To achieve best XM Satellite Radio reception, also refer to the XM radio's owner's manual.

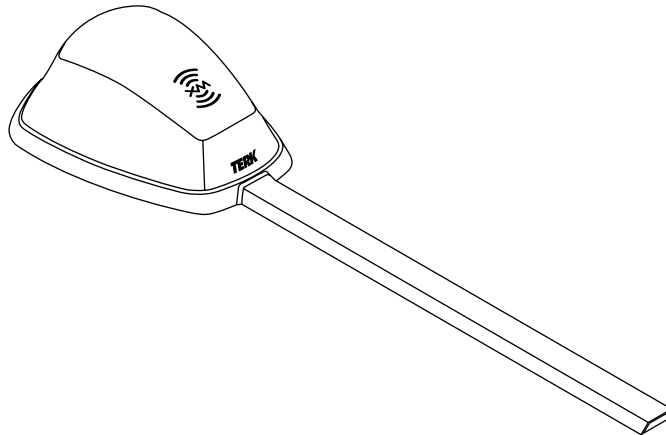

Figure 1. The Terk TRK-SR2 Roof-Mount Satellite Radio Antenna.

TERK

APPLICATIONS

The Terk TRK-SR2 Roof-Mount Satellite Radio Antenna can be installed on a variety of vehicles, as shown below. For details, see *Installation* starting on page 6.

FOUR-DOOR SEDANS

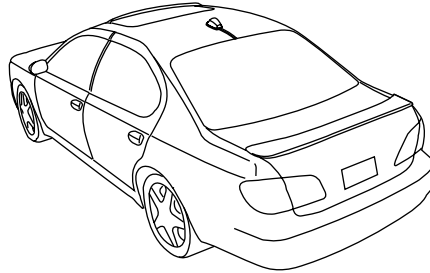

Figure 2. The Terk TRK-SR2 is shown installed on the roof of a four-door sedan.

SUVs

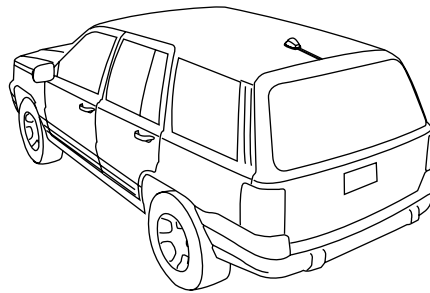

Figure 3. The Terk TRK-SR2 is shown installed on the roof of an SUV.

TWO-DOOR COUPES/HATCHBACKS

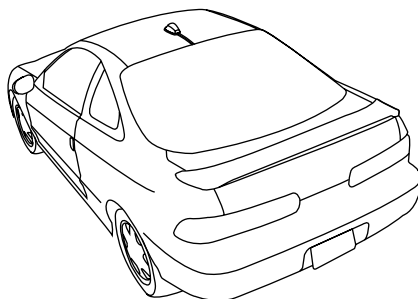

Figure 4. The Terk TRK-SR2 is shown installed on the roof of a two-door coupe.

TRK-SR2 INSTALLATION GUIDE

CONVERTIBLES

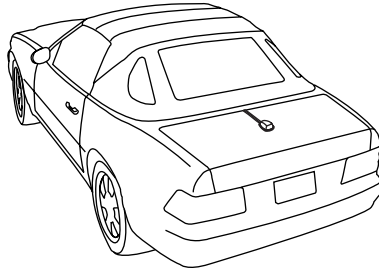

Figure 5. The Terk TRK-SR2 is shown installed on the trunk of a convertible. Note the difference in antenna orientation from other vehicles.

NOTE: The TRK-SR2 can be used on a convertible with a removable metal roof as long as the top is off. Using the roof may cause interference and degraded reception.

VANS/MINIVANS

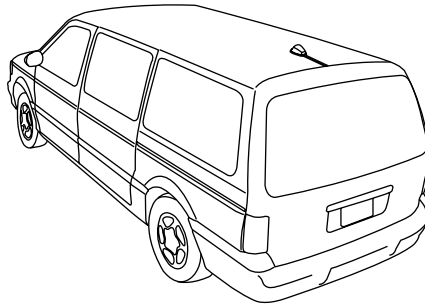

Figure 6. The Terk TRK-SR2 is shown installed on the roof of a minivan.

PICKUP TRUCKS

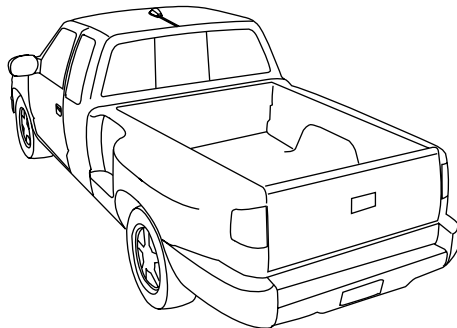

Figure 7. The Terk TRK-SR2 is shown installed on the roof of a pickup truck.



INSTALLATION

TRK-SR2 PARTS

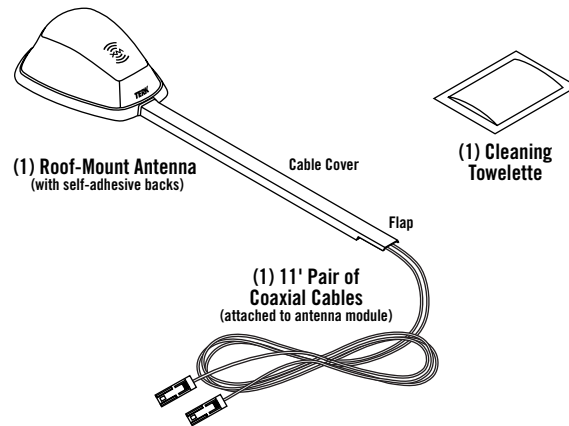

Figure 8. Verify that your TRK-SR2 package includes the above items.

RECOMMENDED TOOLS AND SUPPLIES

Although not necessary, the following tools and supplies may aid in installation:

- Any tool to help cable routing (e.g., flat dental pick, screwdriver, etc.)
- Lubricant (e.g., light machine oil to aid cable routing through old molding)
- Cable tie wraps and adhesive mounting bases (to manage cable routing)
- Tape measure and level (for positioning the antenna)

INSTALLATION PRECAUTIONS AND TIPS

- When selecting an antenna location for the TRK-SR2, make sure the proposed site meets the following conditions:
 - a. The selected site must have a conductive surface area (e.g., metal or aluminum roof) of at least 2-1/4 square feet and be 6 inches from rear window molding.
 - b. Line of sight to satellites must not be blocked by any metal obstructions (e.g., crossbars from a roof rack).
 - c. Choose the highest possible location on the vehicle's roof that satisfies the above conditions and is as flat as possible.
- Although a center position on a roof is the most aesthetically pleasing, if there is an obstruction (e.g., skid ribs, protruding brake light on roof line, etc.) consider offsetting the TRK-SR2 from the center. If this doesn't work, use the Terk TRK-SR1 Glass-Mount Satellite Radio Antenna instead.

TRK-SR2 INSTALLATION GUIDE

- If the vehicle is equipped with a roof rack, adjust the crossbar so it's at least 6 inches away from the TRK-SR2.
- If the vehicle is equipped with a metal sunroof (e.g., Mazda 626), which opens to the outside, allow a minimum distance of 6 inches from the edge of the open sunroof to the TRK-SR2. If this is not possible, use the Terk TRK-SR1 Glass-Mount Satellite Radio Antenna instead.

NOTE: A glass sunroof does not require this minimum mounting distance, since the glass does not block satellite signals nor degrade reception.

- Before mounting the TRK-SR2, make sure the vehicle's roof is above 60 °F, non-condensing, and dry. This will also allow the molding to soften up.
- At a selected antenna site, survey the planned cable route and look for any blocked passages. Consider alternate routes to find the best available path.

NOTE: Take advantage of any existing cable channels (e.g., brake light opening) or wiring conduits to route the cables.

- Avoid running cables through components that may cause excessive chafing. Doing so may erode the jacket and break signal continuity. Also, avoid kinking, pinching, or twisting a cable during a run.
- When routing the cable through small openings, consider removing the plastic cases and inserts from connectors (see Figure 12 on page 9).
- For convertibles with composite trunk lids, attach an aluminum foil "ground plane" of at least 2-1/4 square feet, centered under the antenna module, between the lid and liner.
- When pressing the TRK-SR2 onto the vehicle's roof, apply an initial contact force of 15 to 20 PSI (i.e., steady and firm finger-tip pressure) for 60 seconds. Allow 20 minutes for the self-adhesive backing to set before driving the vehicle.
- After installation, avoid running the vehicle through a car wash for 72 hours.

INSTALLING THE TRK-SR2

1. At the selected site, use an enclosed Cleaning Towelette to clean the installation area on the vehicle's roof.

NOTE: For additional cleaning solution, only use isopropyl alcohol. Do not use any commercial glass cleaners.

2. Peel off both protective backings from the cable cover and antenna module. Lightly position the end of the cable cover at the rear window molding, as shown in Figure 9 on the next page.

NOTE: The end flap should extend over the molding (see Figure 9).

Continued on next page...



INSTALLATION

INSTALLING THE TRK-SR2 (CONTINUED)

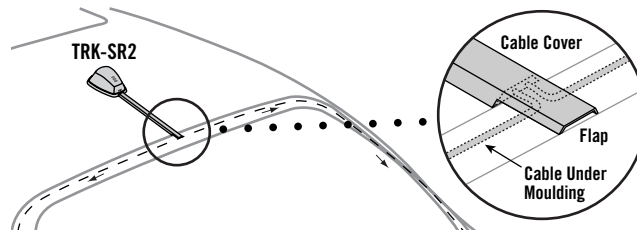

Figure 9. Positioning the TRK-SR2 on a vehicle's roof so the cable cover flap extends over the rear window molding.

3. Continue placing the molding down on the roof, working forward towards the antenna module. Examine the placement and make any desired adjustments.
4. Using steady pressure, firmly press the TRK-SR2 (including cable cover) down for a minimum of 60 seconds to secure adhesion to the roof.
5. Push the cables under the rear window molding and route them to the XM receiver, as shown in Figure 10 below. The cables can be routed separately (as shown) or together along a single route.

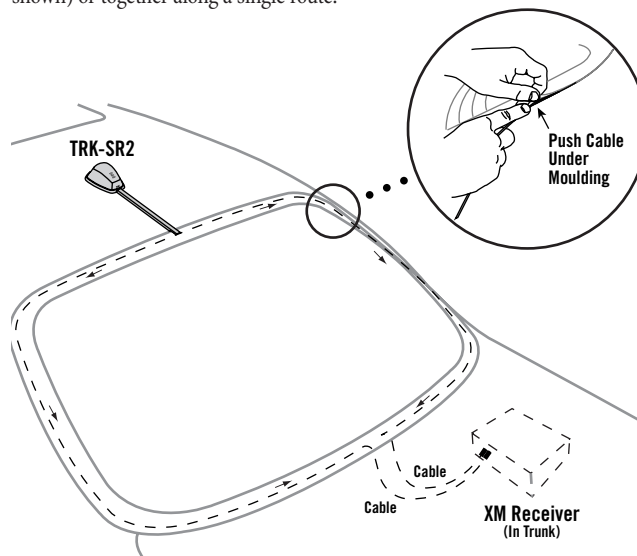

Figure 10. Routing the TRK-SR2's cable along a vehicle's rear window.

NOTE: Use any existing cable channels (e.g., brake light opening) or wiring conduits to route the cables.

TRK-SR2 INSTALLATION GUIDE

- If the XM system is not already installed, temporarily connect power and ground to the system. Connect the TRK-SR2 to your XM receiver, as directed by the receiver's manufacturer (see Figure 11 below).

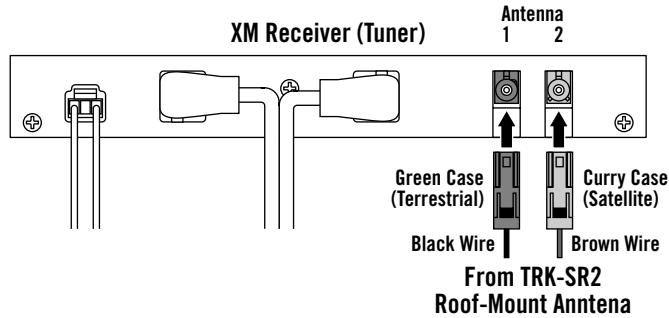

Figure 11. Wiring diagram shows antenna connections to an XM receiver.

NOTE: For the Sony DRN-XM01 Digital Audio Receiver, use a small jeweler's screwdriver to remove the plastic case and inserts from each FAKRA-type SMB connector, as shown in Figure 12 below.

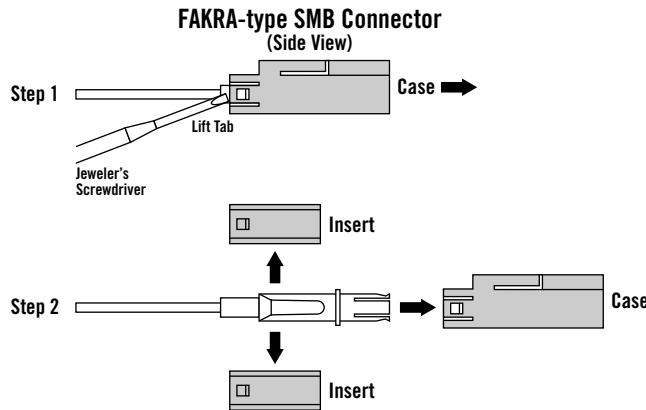

Figure 12. Removing the plastic case and inserts.

- Turn on the XM system and tune to different XM channels. If there are any problems, review the installation steps and verify that each one was performed correctly. Also see *Troubleshooting* on the next page.
- After the system has been tested successfully, route the cable from the antenna to the receiver for best appearance and complete the remaining system installation.

NOTE: For additional help with cable routing, consult your local mobile audio dealer.



USE AND CARE

In normal daily use, the Terk TRK-SR2 Roof-Mount Satellite Radio Antenna is a rugged, high-performance antenna that does not require any special attention.

TROUBLESHOOTING

SYMPTOM

SOLUTIONS

XM radio is on, but no channels are being received.

- Check the cables for continuity from the TRK-SR2 to the XM receiver. Look for nicks or cuts along cable route.
- Call us for help at 1-800-942-TERK (8375) on any business day, between 9 A.M. and 5:30 P.M., EST and ask for Technical Support.

XM radio displays "Antenna" or "Check Antenna" message.

- Check antenna connections to the XM receiver.
- Vehicle may be in an area where there is no line of sight to satellite or ground repeater.

TRK-SR2 INSTALLATION GUIDE

SPECIFICATIONS

Frequency:	2332.5 to 2345.0 MHz
Bandwidth:	12.5 MHz
VSWR:	2:1
Terrestrial Reception:	Linear polarization
Satellite Reception:	Circular polarization
Input Impedance:	50 ohms
Coverage from Tuner:	Terrestrial antenna is omnidirectional
Current Draw:	110 mA typical per antenna LNA
Input Voltage:	4.5 Vdc typical
LNA Noise Figure:	0.8 dB max.
Terrestrial Noise Figure:	1.3 dB max.
Total Active LNA Gain –	
Terrestrial Reception:	18 - 22 dB
Satellite Reception:	20 - 24 dB
Out of Band Filter Attenuation:	25 dB min.
Cables:	11 feet coaxial
Connectors:	FAKRA-type SMB (color coded)
Mounting Material:	Adhesive pads (3M 5356 acrylic foam)
Materials:	Radome impact-resistant glass-filled nylon (paintable)
Radiated Immunity:	100 volts per meter, 200 MHz to 2 GHz
Weight:	6 oz (without cables)
Dimensions –	
Antenna Module:	4-1/4" x 3-3/16" x 1-1/2"
Cable Cover (L x W x H):	6-3/4" x 5/8" x 7/32"
Temperature:	-40 °C to +105 °C, operating -45 °C to +120 °C, storage
Quality and Performance Tests –	
XM Approved:	Per specification XM-TEC-3-0009-RD
AES Approved:	Tested and proven to AES
Terk QA:	Shock and Vibration Proof

Terk Technologies strives to maintain and exceed the highest consumer standards. Due to these ongoing efforts, modifications may be made from time to time to existing products without any prior notice. Specifications and appearance may differ from those listed or shown in this manual. The XM name and related logos are trademarks of XM Satellite Radio, Inc. Terk and Terk Technologies are trademarks of Terk Technologies Corp., Commack, NY.

Part # 49P005

LIMITED WARRANTY

TERK Technologies Corp. (Terk) warrants this product against defects in materials or workmanship for 1 year from the date of purchase. During this warranty period this product will be replaced without charge. This warranty does not cover any damage due to act of God, commercial use, accident, misuse, abuse or negligence.

This warranty is only valid in the USA. Replacement as provided under this warranty is the exclusive remedy of the consumer. Terk shall not be liable for any incidental or consequential damages for breach of any expressed or implied warranty on this product, except to the extent prohibited by applicable law. Any implied warranty or merchantability or fitness for a particular purchase on this product is limited to the duration of this warranty.

ABOUT XM SATELLITE RADIO

For more information about XM Satellite Radio service, visit their web site at:

www.xmradio.com

TERK[®]

Terk Technologies Corporation
63 Mall Drive
Commack, NY 11725

VOICE: (631) 543-1900

FAX: (631) 543-8088

INTERNET: www.terk.com

