

What's in the box?

inno™ car kit CD-INCAR2

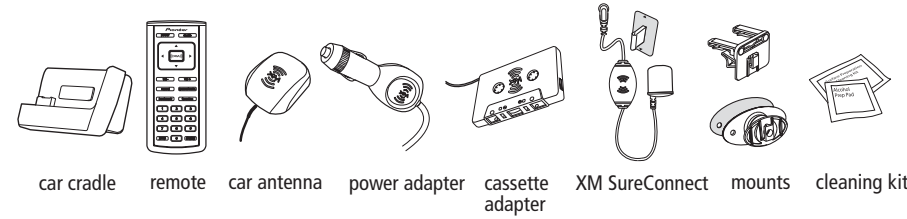

inno™ car kit

- Listen to Live XM and recorded XM content*
- Play MP3 and WMA files
- Manage your tracks, favorite channels, and playlists
- Listen in your vehicle
- Car Kit CD-INCAR2 is not compatible with GEX-INNO1 and was designed to work with GEX-INNO2BK only

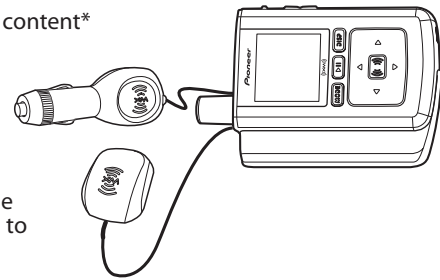

*Hardware and required monthly subscription sold separately. Installation cost and other fees and taxes, including a one-time activation fee may apply. Subscription fee is consumer only. XM products, programming, services, and fees are subject to change, at any time, without notice. Channels with frequent explicit language are indicated with an XL. Channel blocking is available for XM radio receivers by calling 1-800-XM-RADIO. Subscriptions subject to Customer Agreement available at xmradio.com. XM service only available in the 48 contiguous United States. ©2006 XM Satellite Radio Inc. All rights reserved.

Setup: In Vehicle

Choose the best way to mount your car cradle.

How to use the swivel mount

To install the swivel mount, first find a suitable location. The swivel mount's adhesive is very strong and may be difficult to remove. Do not install this mount on leather surfaces and make sure the air temperature is at least 60°F.

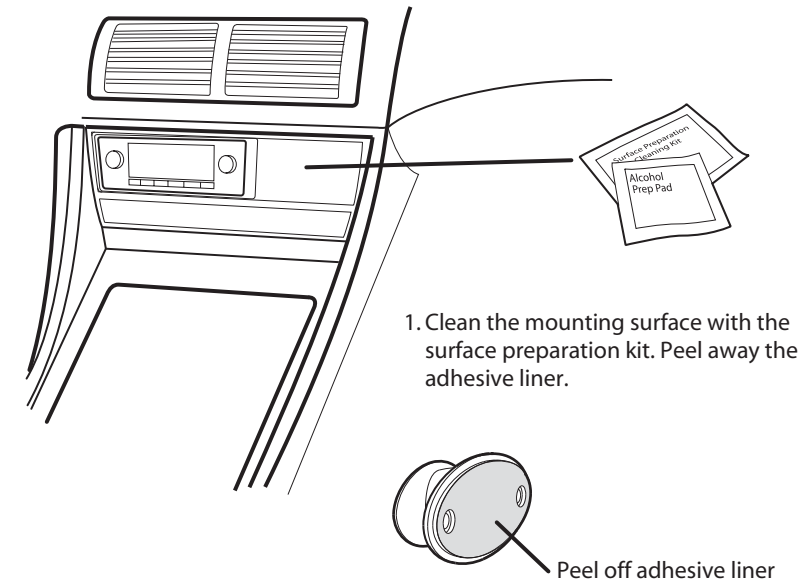

2. Firmly press the swivel mount to the surface for 30 seconds. Allow 24 hours before using the mount.

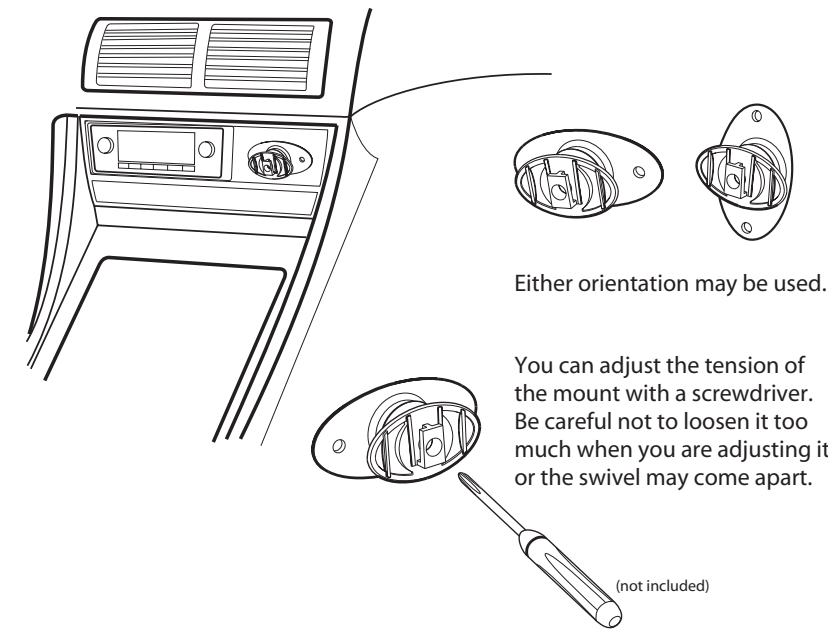

If you need to remove the mount, carefully lift the adhesive pad with your fingers or a spoon. Warming with a hair dryer for several minutes will help soften the adhesive.

How to use the vent mount

To install the vent mount, find a horizontal vent that is strong enough to hold your inno and its car cradle.

1. To insert the vent mount, push it into the vent as shown.

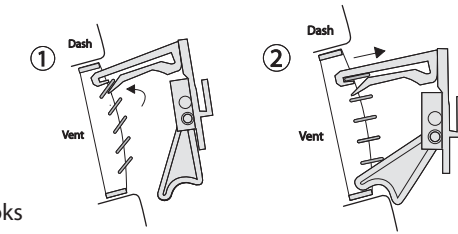

To remove the vent mount, push it into the vent and lift upwards slightly to release the mount's hooks from the vent vane.

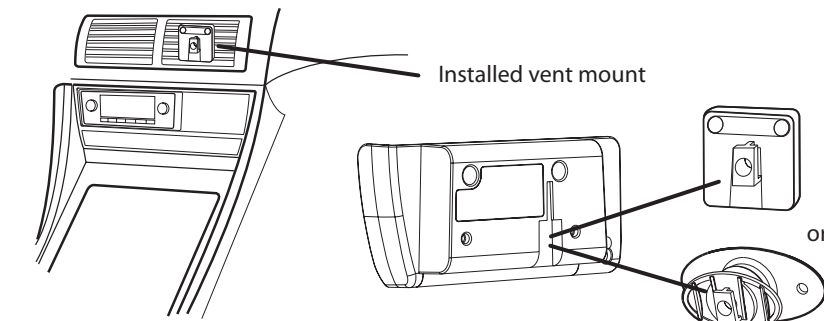

2. Attach the car cradle to either mount by sliding it into place.

How to install the antenna

Every vehicle is different; for your safety, follow all instructions carefully. Consult a professional installer if you have questions.

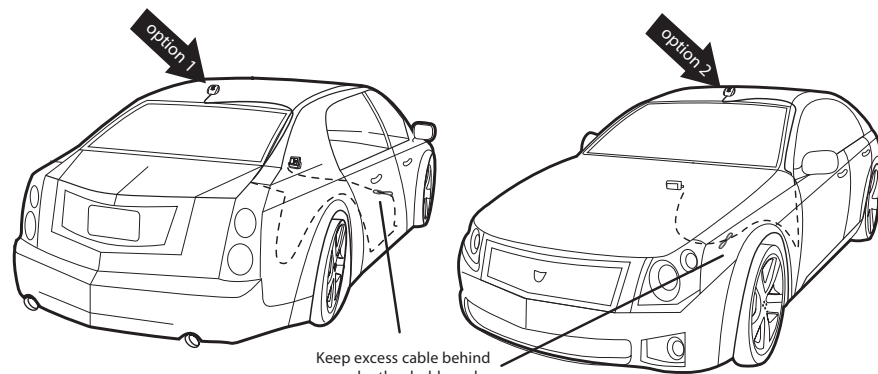

Mount the antenna to the roof or trunk of the vehicle. During installation, make sure you are outdoors and not obstructed by tall buildings.

Warning: Failure to properly install the antenna may result in injury to yourself or to others if it becomes detached during an accident.

How to receive XM through your car stereo

Plug in all of the connectors once you have mounted the radio, installed the antenna or used the included XM SureConnect and plugged in the power adapter.

The line out should be used with the included cassette adapter for the best sound quality.

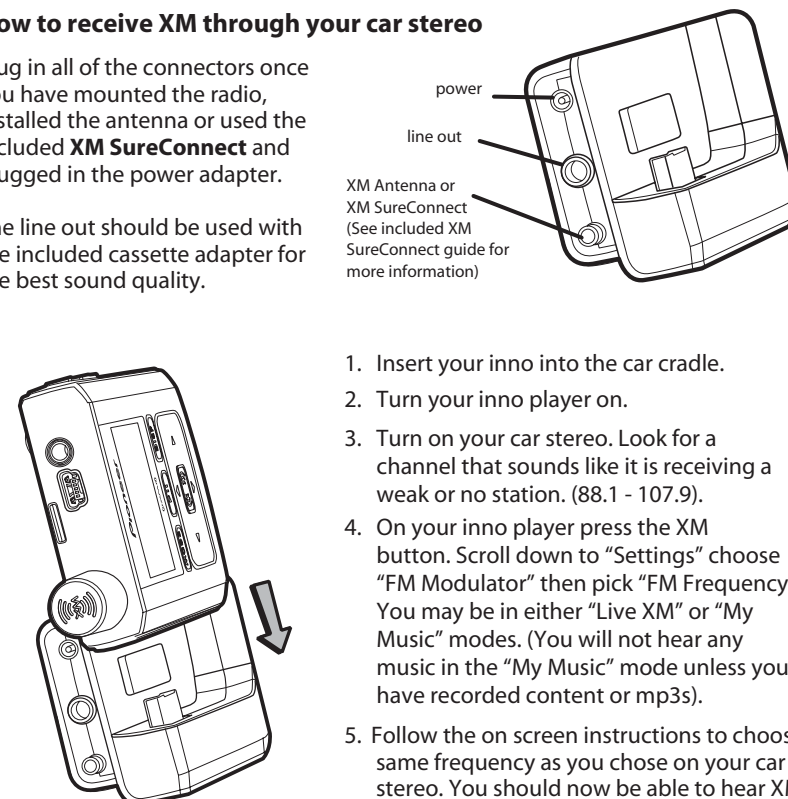

1. Insert your inno into the car cradle.
2. Turn your inno player on.
3. Turn on your car stereo. Look for a channel that sounds like it is receiving a weak or no station. (88.1 - 107.9).
4. On your inno player press the XM button. Scroll down to "Settings" choose "FM Modulator" then pick "FM Frequency." You may be in either "Live XM" or "My Music" modes. (You will not hear any music in the "My Music" mode unless you have recorded content or mp3s).
5. Follow the on screen instructions to choose the same frequency as you chose on your car stereo. You should now be able to hear XM through your car stereo.

Protect your ears

- Take care so that the earbud cable is not caught by your arm or other objects while walking or exercising.
- Do not turn up the volume too high. Doctors warn against prolonged exposure to high volume.
- Stop using your inno or turn the volume down if you have ringing in your ears.

Sound can be deceiving. Over time your hearing "comfort level" adapts to higher volumes of sound. So what sounds "normal" can actually be loud and harmful to your hearing. Set your equipment at a safe level BEFORE your hearing adapts.

To establish a safer level: Start your volume control at a low setting; Slowly increase the sound until you can hear it comfortably and clearly, without distortion.

Once you have established a comfortable sound level: Set the dial and leave it there; taking a minute to do this now will help to preserve hearing. Pioneer and the Consumer Electronics Association recommend you avoid prolonged exposure to excessive noise. Under constant exposure such as sustained listening, sound levels above 85 decibels can be dangerous without hearing protection. (For reference, a garbage disposal or loud shouting at 3 feet away are around 80 decibels; a food blender or gas lawn mower at 3 feet away are around 90 decibels.) The longer your exposure and/or higher the sound level, the greater the danger of permanent hearing damage. Pioneer disclaims all liability for hearing loss, bodily injury or property damage as a result of use or misuse of this product.

On all complaints and concerns call Customer Support at 1-800-421-1404

For hook-up and operation of your unit or to locate an Authorized Service Company, please call or write:
PIONEER ELECTRONICS SERVICE, INC.
P.O. BOX 1760, LONG BEACH, CALIFORNIA 90810
1-800-421-1404
www.pioneerelectronics.com

FCC Statement

Please note that the power cable that has been supplied with your device is supplied with permanently attached ferrite beads. It is the responsibility of the user to use the power cable with the ferrite beads.

The user is cautioned that changes or modifications not expressly approved by XM Satellite Radio Inc. can void the user's authority to operate this device.

This device complies with Part 15 of the FCC Rules. Operation is subject to the following two conditions:
(1) This device may not cause harmful interference.
(2) This device must accept any interference received, including interference that may cause undesired operation.

This equipment has been tested and found to comply with the limits for a Class B digital device, pursuant to Part 15 of the FCC Rules. These limits are designed to provide reasonable protection against harmful interference in a residential installation.

This equipment generates, uses, and can radiate radio frequency energy and, if not installed and used in accordance with the installation instructions, may cause harmful interference to radio communications. However, there is no guarantee that interference will not occur in a particular installation. If this equipment does cause harmful interference to radio or television reception, which can be determined by turning the equipment off and on, the user is encouraged to try to correct the interference by one or more of the following measures:

- Reorient or relocate the receiving antenna of the affected receiver.
- Increase the separation between the XM equipment and the affected receiver.
- Connect the XM equipment into an outlet on a circuit different from that to which the affected receiver is connected.
- Consult the dealer or an experienced radio/TV technician for help.

Warning: The FCC and FAA have not certified the inno Satellite Radio Receiver for use in any aircraft (neither portable nor permanent installation). Therefore, XM Satellite Radio cannot support this type of application or installation.

inno™ home kit CD-INHOME2

What's in the box?

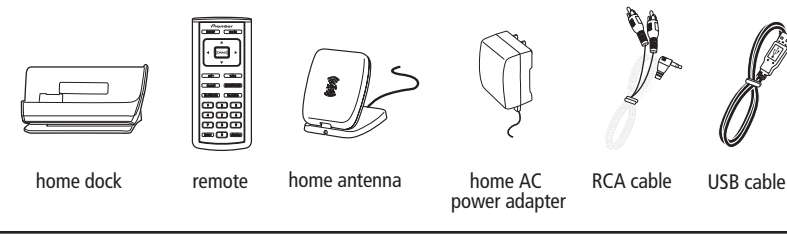

inno™ home kit

- Listen to Live XM and recorded XM content
- Play MP3 and WMA files
- Manage your tracks, favorite channels, and playlists
- Listen in your home or office

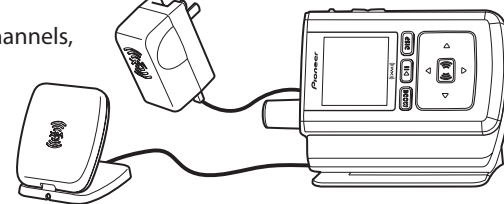

*Hardware and required monthly subscription sold separately. Subscription required to maintain access to saved XM programming. Installation cost and other fees and taxes, including a one-time activation fee may apply. Subscription fee is consumer only. XM products, programming, services, and fees are subject to change, at any time, without notice. Channels with frequent explicit language are indicated with an XL. Channel blocking is available for XM radio receivers by calling 1-800-XM-RADIO. Subscriptions subject to Customer Agreement available at xmradio.com. XM service only available in the 48 contiguous United States. ©2006 XM Satellite Radio Inc. All rights reserved.

Remote

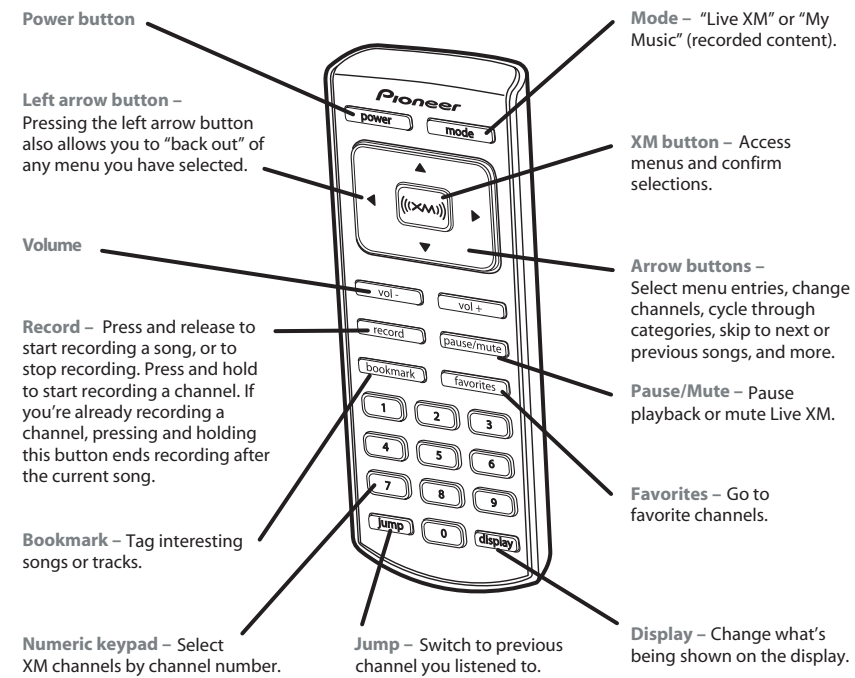

Setup: At Home

1. Insert inno into the home dock.

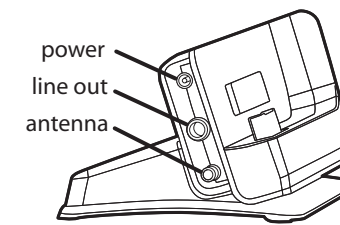
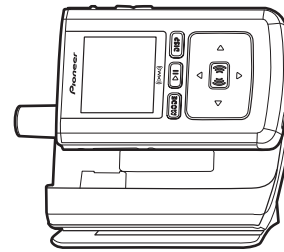

2. Connect inno to your audio system. Connect the power adapter, RCA cable and home antenna.
3. You can also connect inno to your computer. See your inno user guide for installation and requirements.

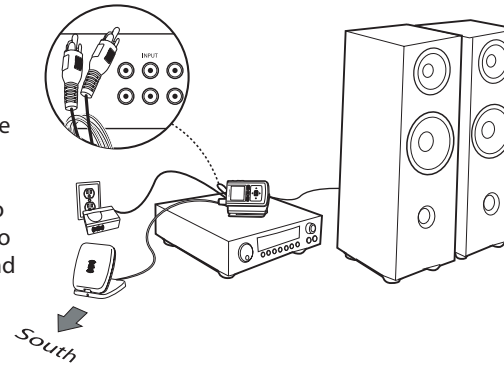

! WARNING: Use only the USB supplied in the package. Other USB cables may not allow your inno to charge its battery or communicate with your PC.



install guide
CD-INHOME2 & CD-INCAR2



! Important: This manual contains important safety and operating information. Please read, understand, and follow the instructions in this manual. Failure to do so could result in personal injury, death, and/or damage to your inno accessories, and/or to your vehicle or property

CD-INCAR2
 CD-INHOME2
Printed on Recycled Paper
 ©2006 Pioneer Electronics Service, Inc. All rights reserved.
 XM name and related logos are trademarks of XM Satellite Radio Inc.
 inno is trademark of Pioneer Electronics (U.S.A.) Inc.
 All other trademarks are property of their respective owners.
<http://www.pioneer-electronics.com>

1-800-421-1404
 LONG BEACH, CALIFORNIA 90810
 P.O. BOX 1760
 PIONEER ELECTRONICS SERVICE, INC.

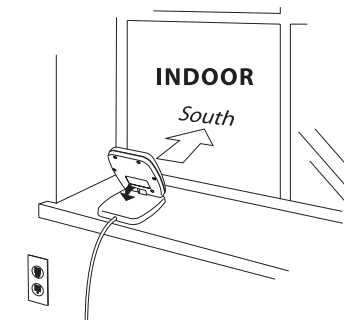

4. Place the home antenna in or near a southern facing window for optimal indoor reception.

5. To optimize signal reception, you may mount the home antenna outdoors, facing south.

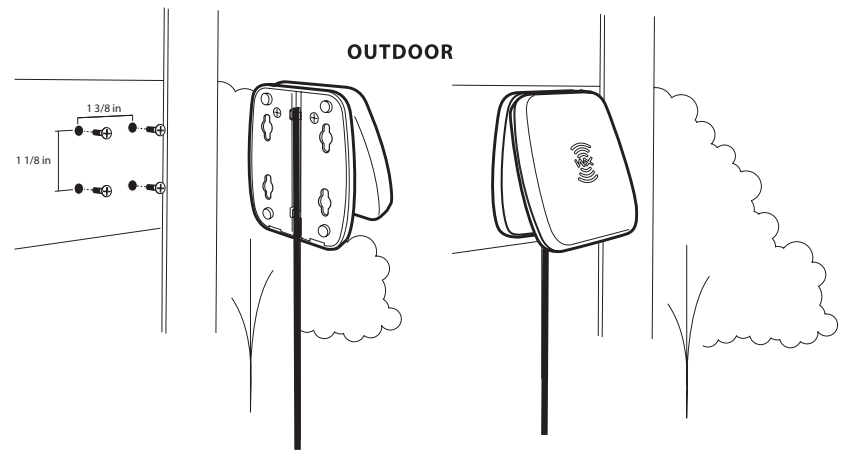

LIMITED WARRANTY

WARRANTY VALID ONLY IN COUNTRY OF PRODUCT PURCHASE

WARRANTY
 Pioneer Electronics (USA) Inc. (PUSA), and Pioneer Electronics of Canada, Inc. (POC), warrants that products distributed by PUSA in the U.S.A., and by POC in Canada that fail to function properly under normal use due to a manufacturing defect when installed and operated according to the owner's manual enclosed with the unit will be repaired or replaced with a unit of comparable value, at the option of PUSA or POC, without charge to you for parts or actual repair work. Parts supplied under this warranty may be new or rebuilt at the option of PUSA or POC.

THIS LIMITED WARRANTY APPLIES TO THE ORIGINAL OR ANY SUBSEQUENT OWNER OF THIS PIONEER PRODUCT DURING THE WARRANTY PERIOD PROVIDED THE PRODUCT WAS PURCHASED FROM AN AUTHORIZED PIONEER DISTRIBUTOR/DEALER IN THE U.S.A. OR CANADA. YOU WILL BE REQUIRED TO PROVIDE A SALES RECEIPT OR OTHER VALID PROOF OF PURCHASE SHOWING THE DATE OF ORIGINAL PURCHASE. THE PRODUCT MUST BE DELIVERED WITHIN THE WARRANTY PERIOD, TRANSPORTATION PREPAID, ONLY FROM WITHIN THE COUNTRY OF PURCHASE AS EXPLAINED IN THIS DOCUMENT. YOU WILL BE RESPONSIBLE FOR REMOVAL AND INSTALLATION OF THE PRODUCT. PUSA OR POC, AS APPROPRIATE, WILL PAY TO RETURN THE REPAIRED OR REPLACEMENT PRODUCT TO YOU WITHIN THE COUNTRY OF PURCHASE.

ACCESSORY WARRANTY PERIOD..... 1 Year Parts & Labor

WHAT IS NOT COVERED
 IF THIS PRODUCT WAS PURCHASED FROM AN UNAUTHORIZED DISTRIBUTOR, THERE ARE NO WARRANTIES, EXPRESS OR IMPLIED, INCLUDING THE IMPLIED WARRANTY OF MERCHANTABILITY AND THE IMPLIED WARRANTY OF FITNESS FOR A PARTICULAR PURPOSE AND THIS PRODUCT IS SOLD STRICTLY "AS IS" AND "WITH ALL FAULTS". PIONEER SHALL NOT BE LIABLE FOR ANY CONSEQUENTIAL AND/OR INCIDENTAL DAMAGES. PIONEER DOES NOT WARRANT ANY PRODUCT LISTED ABOVE WHEN IT IS USED IN A TRADE OR BUSINESS OR IN ANY INDUSTRIAL OR COMMERCIAL APPLICATION. THIS WARRANTY DOES NOT APPLY IF THE PRODUCT HAS BEEN SUBJECTED TO POWER IN EXCESS OF ITS PUBLISHED POWER RATING. THIS WARRANTY DOES NOT COVER ANY APPEARANCE ITEM, USER ATTACHED ANTENNA, ANY

DAMAGE TO THE PRODUCT RESULTING FROM ALTERATIONS, MODIFICATIONS NOT AUTHORIZED IN WRITING BY PIONEER, ACCIDENT, MISUSE OR ABUSE, DAMAGE DUE TO LIGHTNING OR TO POWER SURGES, SUBSEQUENT DAMAGE FROM LEAKING, DAMAGE FROM INOPERATIVE BATTERIES, OR THE USE OF BATTERIES NOT CONFORMING TO THOSE SPECIFIED IN THE OWNER'S MANUAL. THIS WARRANTY DOES NOT COVER THE COST OF PARTS OR LABOR WHICH WOULD BE OTHERWISE PROVIDED WITHOUT CHARGE UNDER THIS WARRANTY OBTAINED FROM ANY SOURCE OTHER THAN A PIONEER AUTHORIZED SERVICE COMPANY OR OTHER DESIGNATED LOCATION. THIS WARRANTY DOES NOT COVER DEFECTS OR DAMAGE CAUSED BY THE USE OF UNAUTHORIZED PARTS OR LABOR FROM IMPROPER MAINTENANCE, ALTERED, DEFACED, OR REMOVED SERIAL NUMBERS VOID THIS ENTIRE WARRANTY.

NO OTHER WARRANTIES
 IN THE U.S.A. - PIONEER LIMITS ITS OBLIGATIONS UNDER ANY IMPLIED WARRANTIES INCLUDING, BUT NOT LIMITED TO, THE IMPLIED WARRANTIES OF MERCHANTABILITY AND FITNESS FOR A PARTICULAR PURPOSE, TO A PERIOD NOT TO EXCEED THE WARRANTY PERIOD. NO WARRANTIES SHALL APPLY AFTER THE WARRANTY PERIOD. SOME STATES DO NOT ALLOW LIMITATIONS ON HOW LONG AN IMPLIED WARRANTY LASTS AND SOME STATES DO NOT ALLOW THE EXCLUSIONS OR LIMITATIONS OF INCIDENTAL OR CONSEQUENTIAL DAMAGES, SO THE ABOVE LIMITATIONS OR EXCLUSIONS MAY NOT APPLY TO YOU. THIS WARRANTY GIVES YOU SPECIFIC LEGAL RIGHTS AND YOU MAY HAVE OTHER RIGHTS WHICH MAY VARY FROM STATE TO STATE.

IN CANADA – EXCEPT AS EXPRESSLY PROVIDED HEREIN, THERE ARE NO REPRESENTATIONS, WARRANTIES, OBLIGATIONS OR CONDITIONS, IMPLIED, STATUTORY OR OTHERWISE, APPLICABLE TO THIS PRODUCT.

TO OBTAIN SERVICE
 PUSA has appointed a number of Authorized Service Companies throughout the U.S.A. should your product require service. To receive warranty service you need to present your sales receipt showing place and date of original owner's transaction. If shipping the unit you will need to package it carefully and send it, transportation prepaid by a traceable, insured method, to an Authorized Service Company. Package the product using adequate padding material to prevent damage in transit. Include your name, address and telephone number where you can be reached during business hours.