

Contents

Operating Instructions

WARNING

WARNING	3
CAUTION	3
PRECAUTIONS	3

Getting Started

Turning Power On and Off	5
Detaching and Attaching the Front Panel	5
Initial System Start-Up	6
Setting Time	6
Adjusting Volume	6
Lowering Volume Quickly	6

XM Radio

Receiving XM Channels	7
Checking the XM Radio ID Number	7
Storing XM Channel Presets	7
Receiving Stored XM Channels	7
Channel/Category Search	7
Quick Search	8
Changing the Display	8
Setting the Tuning Method	8
Setting the Auxiliary Data Field Display	8
Direct Channel Access	8

Radio

Listening to Radio	9
Manual Storing of Station Presets	9
Automatic Memory of Station Presets	9
Tuning to Preset Stations	9
Station Title Search Function	9
Quick Search Function	9

CD

Playback	10
Repeat Play	10
M.I.X. (Random Play)	10
Scanning Programs	10
Track Search	10
Quick Search	10

Sound Setting

Adjusting Balance (Between Left and Right)/ Fader (Between Front and Rear)/Defeat	11
Setting the Bass Control	11
Setting the Treble Control	12
Setting the Bass Type	12
Setting the MX Mode	12

Other Functions

Displaying the Title/Text	13
Titling Discs/Stations	14
Erasing Disc Title/Station Title	14
Displaying Time	14
Blackout Mode On and Off	14

SETUP

General Customizing

Subwoofer On and Off	15
Scroll Setting	15

External Device

Turning Mute Mode On/Off	15
Setting the AUX Mode (V-Link)	15
Connecting to an External Amplifier	16
Setting Tone Defeat for External Devices	16

Changer (Optional)

Controlling CD Changer (Optional)	16
Playing MP3 Files with the CD Changer (Optional)	17
Multi-Changer Selection (Optional)	17
Repeat Play	17
M.I.X. (Random Play)	17
Scanning Programs	18
Track Search	18
File/Folder Search (only for MP3 compatible changer)	18
Quick Search	18
Playing MP3 Data	18

MobileHub™ Link Operation (Optional)

About MobileHub™ Link	19
Telephone Mode ON/OFF	19
Incoming Calls	19
Setting the Automatic Calling	19
Calling	19
SMS (Short Message Service) Operation	20

Information

In Case of Difficulty	21
Specifications	23
Controls on Remote Control (Optional)	23

Installation and Connections

Warning	24
Caution	24
Precautions	24
Installation	25
Connections	26

LIMITED WARRANTY

Operating Instructions

WARNING

WARNING

This symbol means important instructions. Failure to heed them can result in serious injury or death.

DO NOT OPERATE ANY FUNCTION THAT TAKES YOUR ATTENTION AWAY FROM SAFELY DRIVING YOUR VEHICLE.

Any function that requires your prolonged attention should only be performed after coming to a complete stop. Always stop the vehicle in a safe location before performing these functions. Failure to do so may result in an accident.

KEEP THE VOLUME AT A LEVEL WHERE YOU CAN STILL HEAR OUTSIDE NOISE WHILE DRIVING.

Failure to do so may result in an accident.

MINIMIZE DISPLAY VIEWING WHILE DRIVING.

Viewing the display may distract the driver from looking ahead of the vehicle and cause an accident.

DO NOT DISASSEMBLE OR ALTER.

Doing so may result in an accident, fire or electric shock.

USE ONLY IN CARS WITH A 12 VOLT NEGATIVE GROUND.

(Check with your dealer if you are not sure.) Failure to do so may result in fire, etc.

KEEP SMALL OBJECTS SUCH AS BATTERIES OUT OF THE REACH OF CHILDREN.

Swallowing them may result in serious injury. If swallowed, consult a physician immediately.

USE THE CORRECT AMPERE RATING WHEN REPLACING FUSES.

Failure to do so may result in fire or electric shock.

DO NOT BLOCK VENTS OR RADIATOR PANELS.

Doing so may cause heat to build up inside and may result in fire.

USE THIS PRODUCT FOR MOBILE 12V APPLICATIONS.

Use for other than its designed application may result in fire, electric shock or other injury.

DO NOT PLACE HANDS, FINGERS OR FOREIGN OBJECTS IN INSERTION SLOTS OR GAPS.

Doing so may result in personal injury or damage to the product.



CAUTION

This symbol means important instructions. Failure to heed them can result in injury or material property damage.

HALT USE IMMEDIATELY IF A PROBLEM APPEARS.

Failure to do so may cause personal injury or damage to the product. Return it to your authorized Alpine dealer or the nearest Alpine Service Center for repairing.

DO NOT MIX NEW BATTERIES WITH OLD BATTERIES. INSERT WITH THE CORRECT BATTERY POLARITY.

When inserting the batteries, be sure to observe proper polarity (+ and -) as instructed. Rupture or chemical leakage from the battery may cause fire or personal injury.



PRECAUTIONS

Temperature

Be sure the temperature inside the vehicle is between +60°C (+140°F) and -10°C (+14°F) before turning your unit on.

Moisture Condensation

You may notice the CD playback sound wavering due to condensation. If this happens, remove the disc from the player and wait about an hour for the moisture to evaporate.

Damaged Disc

Do not attempt to play cracked, warped, or damaged discs. Playing a bad disc could severely damage the playback mechanism.

Maintenance

If you have problems, do not attempt to repair the unit yourself. Return it to your Alpine dealer or the nearest Alpine Service Station for servicing.

PRECAUTIONS

Never Attempt the Following

Do not grip or pull out the disc while it is being pulled back into the player by the automatic reloading mechanism.

Do not attempt to insert a disc into the unit when the unit power is off.

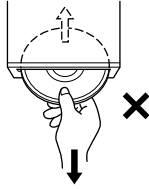

Inserting Discs

Your player accepts only one disc at a time for playback. Do not attempt to load more than one disc.

Make sure the label side is facing up when you insert the disc. Your player will automatically eject any disc that is inserted incorrectly. If the player continues to eject a correctly inserted disc, push the RESET switch with a pointed object such as a ballpoint pen.

Playing a disc while driving on a very bumpy road may result in skips, but this will not scratch the disc or damage the player.

New Discs

As a protective measure to prevent the CD from jamming, the CD player will automatically eject discs with irregular surfaces or inserted incorrectly. When a new disc is inserted into the player and ejected after initial loading, using your finger, feel around the inside of the center hole and outside edge of the disc. If you feel any small bumps or irregularities, this could inhibit proper loading of the disc. To remove the bumps, rub the inside edge of the hole and outside edge of the disc with a ballpoint pen or other such instrument, then insert the disc again.

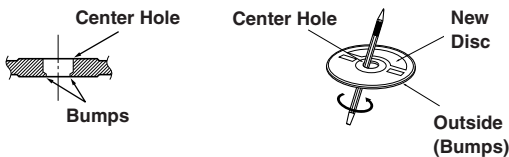

Irregular Shaped Discs

Be sure to use round shape discs only for this unit and never use any special shape discs.

Use of special shape discs may cause damage to the mechanism.

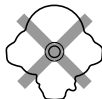

Installation Location

Make sure the CDA-9820XM will not be installed in a location subjected to:

- Direct sun and heat
- High humidity and water
- Excessive dust
- Excessive vibrations

Correct Handling

Do not drop the disc while handling. Hold the disc so you will not leave fingerprints on the surface. Do not affix tape, paper, or gummed labels to the disc. Do not write on the disc.

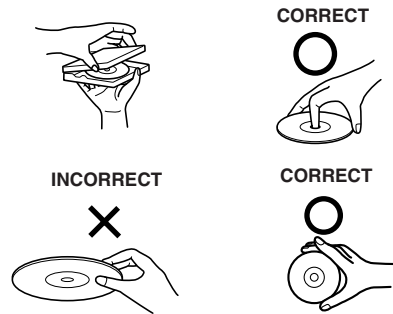

Disc Cleaning

Fingerprints, dust, or soil on the surface of the disc could cause the CD player to skip. For routine cleaning, wipe the playing surface with a clean, soft cloth from the center of the disc to the outer edge. If the surface is heavily soiled, dampen a clean, soft cloth in a solution of mild neutral detergent before cleaning the disc.



Disc Accessories

There are various accessories available on the market for protecting the disc surface and improving sound quality. However, most of them will influence the thickness and/or diameter of the disc. Using such accessories can cause the disc to be out of standard specifications and may create operational problems. We recommend not using these accessories on discs played in Alpine CD players.

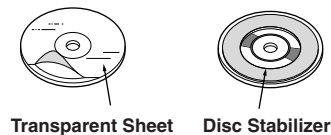

On handling Compact Discs (CD/CD-R/CD-RW)

- Do not touch the surface.
- Do not expose the disc to direct sunlight.
- Do not affix stickers or labels and do not write on the surface.
- Clean the disc when it is dusty.
- Make sure that there are no bumps around the disc.
- Do not use commercially available disc accessories.

Do not leave the disc in the car or the unit for a long time. Never expose the disc to direct sunlight. Heat and humidity may damage the CD and you may not be able to play it again.

To customers using CD-R/CD-RW

- If a CD-R/CD-RW cannot be played back, make sure the last recording session was closed (finalized).
- Finalize the CD-R/CD-RW if necessary, and attempt playback again.

About media that can be played with the CDA-9820XM.

Use only compact discs with the label side showing the CD logo marks below.



If you use unspecified compact discs, correct performance cannot be guaranteed.

You can play CD-Rs (CD-Recordable)/CD-RWs (CD-Recordable/ReWritable) for audio use on this unit. However, you cannot play CD-Rs/CD-RWs containing MP3 formatted audio files.

- Some of the following CDs may not play on this unit: Flawed CDs, CDs with fingerprints, CDs exposed to extreme temperatures or sunlight (e.g., left in the car or this unit), CDs recorded under unstable conditions, CDs not designed for audio use, CDs on which a recording failed or a re-recording was attempted.

About the alphanumeric display of this unit.

- All English lower case characters are displayed as upper case on this unit.
- The alphanumeric display in the following table shows alphanumeric characters/numbers that may be difficult to distinguish.

Alphanumeric	0	2	5	6	8	A	B	D
Display	0	2	5	6	8	A	B	D
Alphanumeric	G	H	K	M	Q	R	S	Z
Display	G	H	K	M	Q	R	S	Z

Getting Started

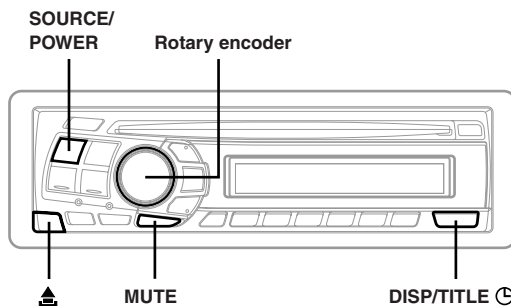

Turning Power On and Off

Press **SOURCE/POWER** to turn on the unit.

- The unit can be turned on by pressing any other button except eject and **DISP/TITLE** .

Press and hold **SOURCE/POWER** for at least **3 seconds** to turn off the unit.

- The first time power is turned on, the volume will start from level 12.

Detaching and Attaching the Front Panel

Detaching

- 1 Turn off the unit power.
- 2 Press (Release) at the lower left side until the front panel pops out.
- 3 Grasp the left side of the front panel and pull it out.

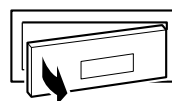

- The front panel may become hot in normal usage (especially the connector terminals on the back of the front panel.) This is not a malfunction.
- To protect the front panel, place it in the supplied carrying case.

Attaching

- 1 Insert the right side of the front panel into the main unit. Align the groove on the front panel with the projections on the main unit.
- 2 Push the left side of the front panel until it locks firmly into the main unit.

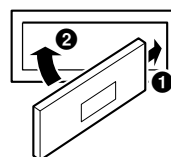

- Before attaching the front panel, make sure that there is no dirt or dust on the connector terminals and no foreign object between the front panel and the main unit.
- Attach the front panel carefully. Hold the panel by its sides to avoid pushing any buttons by mistake.

Initial System Start-Up

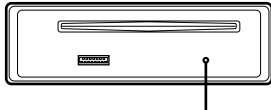

Be sure to press the RESET switch when using the unit for the first time, after installing the CD changer, after changing the car battery, etc.

- 1 Turn off the unit power.
- 2 Remove the detachable front panel.
- 3 Press **RESET** with a ball-point pen or similar pointed object.



RESET switch

Setting Time

- 1 Press **DISP/TITLE**  repeatedly until the time is displayed.
For details, see "Displaying the Title/Text" (page 13).
 - 2 Press and hold **DISP/TITLE**  for at least 3 seconds while the time is displayed.
The time indication will blink.
 - 3 Turn the **Rotary encoder** to adjust the hours.
 - 4 When the hour has been adjusted, press the **Rotary encoder**.
 - 5 Turn the **Rotary encoder** to adjust the minutes while the time indication is blinking.
The time is automatically set 5 seconds after the minute adjustment. The time can also be manually set by pressing the Rotary encoder.
- *To synchronize the clock to a time signal, press and hold the **Rotary encoder** for at least 3 seconds after setting the "hour." Minutes will be indicated as 00. If you press and hold the **Rotary encoder** for more than 3 seconds when the display shows over "30," hours will advance.*

Adjusting Volume

Turn the **Rotary encoder** until the desired sound is obtained.

Volume : 0 ~ 35

Lowering Volume Quickly

Activating the Audio Mute function will instantly lower the volume level by 20 dB.

Press **MUTE** to activate the MUTE mode.

The audio level will decrease by about 20 dB.

Pressing **MUTE** again will bring the audio back to its previous level.

XM Radio

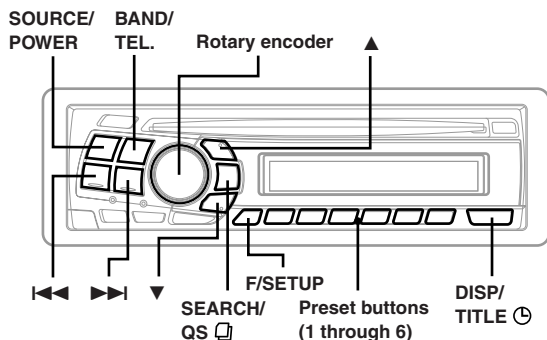

Receiving XM Channels

XM Satellite Radio* is the next generation of audio entertainment, with up to 100 brand-new digital channels. For a small monthly fee, subscribers can hear crystal-clear music, sports, news and talk, coast-to-coast via satellite. For more information, visit XM's website at www.xmradio.com or call 1-800-852-9696.

How to Subscribe

Make sure that the optional XM antenna has been installed before beginning the subscription process.

Listeners can subscribe by visiting XM's Website at www.xmradio.com or by calling 1-800-852-9696. Customers should have their Radio ID ready; see "checking the XM Radio ID Number" on this page.

* XM and its corresponding logos are trademarks of XM Satellite Radio Inc.

- Do not connect an external XM Tuner to this unit. Connecting an external tuner unit will cause an "ERROR" to be displayed and all functions are disabled.
- The X1, X2 or X3 band illuminates when in XM mode.

1 Press SOURCE/POWER to select XM mode.

2 Press BAND/TEL. to select X1, X2 or X3.

Each press changes the band:

X1 (XM1) → X2 (XM2) → X3 (XM3) → X1 (XM1)

3 Press I◀◀ or ▶▶I to select the desired channel.

Holding the I◀◀ or ▶▶I will change channels continuously.

- The channel number display automatically changes after a few seconds to the channel name display.
- You can change Category by pressing ▲ or ▼.

Checking the XM Radio ID Number

You need to provide XM with the unique XM Radio ID number for your CDA-9820XM in order to subscribe to XM's programming.

This number is an 8 character alphanumeric number that is printed on a label directly on the bottom of the unit.

It can also be displayed on the screen of this unit in the following way.

1 While receiving X1, X2 or X3, press I◀◀ or ▶▶I to select channel "0."

The unit alternately displays "RADIO ID" for 2 seconds, then the ID number for 10 seconds.

While displaying "RADIO ID" as shown above, Blackout (page 14) becomes nonfunctional.

2 To cancel the ID number display, set the channel to other than "0."

- You cannot use "O," "S," "I," or "F" for the ID Number.
- You can check your ID number printed on the label on the bottom of the CDA-9820XM, or on the label on the packing box.

Storing XM Channel Presets

1 Press BAND/TEL. to select the desired band (X1, X2 or X3) you want to store.

2 After tuning in the desired channel, press and hold any one of the preset buttons (1 through 6) that you want to store the station on for at least 2 seconds.

The selected station is stored.

3 Repeat the procedure to store up to 5 other channels onto the same band.

- To use this procedure for other bands, simply select the band desired and repeat the procedure.
- A total of 18 channels can be stored in the preset memory (6 channels for each band; X1, X2 and X3).
- If you store a channel in a preset memory which already has a station, the current channel will be cleared and replaced with the new one.

Receiving Stored XM Channels

1 Press BAND/TEL. to select the desired band (X1, X2 or X3).

X1 → X2 → X3 → X1

2 Press the channel preset button that has your desired satellite channel in memory.

Channel/Category Search

You can search for programs by Channel No. or Category.



1 Press SEARCH/QS  in the XM mode to select Channel Search mode or Category Search mode.

Channel Search mode:

2 Turn the Rotary encoder to select the desired Channel No.* within 10 seconds.

* The Channel No. is selected within the selected Category.



3 Press Rotary encoder to receive the selected Channel No.

- Search mode is canceled by pressing and holding **SEARCH/QS**  for at least 2 seconds in Channel Search mode.
- When "Setting the tuning method" is set to "CH NO" in the Channel Search mode, the search is performed in order of channel number. When "Setting the tuning method" is set to "ALPHABET" in the Channel Search mode, the channel name is searched in alphabetic order.
- While in Channel Search mode, press **▲** or **▼** to select the another Category.
- While in Channel Search mode, press **SEARCH/QS**  to switch to the Category Search mode.

Category Search mode:

2 Turn the Rotary encoder to select the desired Category within 10 seconds.

3 Press Rotary encoder to receive the selected Category.

- Search mode is canceled by pressing and holding **SEARCH/QS**  for at least 2 seconds in Category Search mode.
- While in Category Search mode, press **SEARCH/QS**  to switch to Channel Search mode.

Quick Search

You can search for all Channels.

1 Press and hold **SEARCH/QS  for at least 2 seconds in XM mode to activate Quick Search mode.**

2 Turn the Rotary encoder to select the desired Channel within 10 seconds.

The selected Channel is received.

Changing the Display

Text information, such as the channel name, artist name/feature, and song/program title, is available with each XM channel. The unit can display this text information as explained below.



In XM mode, press **DISP/TITLE .**

Each time you press this button, the display changes as shown below.

Channel Number*¹ → Channel Name → Song Title → Artist Name → Auxiliary Data Field*² → Clock → Channel Number*¹

*¹ The Channel Name display automatically changes after a few seconds.

*² When ADF is turned OFF, this information is not displayed (see "Setting the Auxiliary Data Field Display" on this page).

- When the "Scroll Setting" (page 15) is set to "SCR AUTO," the display scrolls continuously. When the Scroll Setting is set to "SCR MANU," the display scrolls only once after any function is performed (PRESET, BAND, SEARCH, etc.). Press and hold **DISP/TITLE**  for more than 3 seconds to scroll the display manually.
- "Channel Number" and "Clock" displays do not scroll.
- Depending on the model, the display may differ from the one shown above.
- When displaying the Channel Name, the number , described in the section "About the indicator display" (page 13), is lit. When displaying the Artist Name, the number , described in the section "About the indicator display" (page 13), is lit.

Setting the tuning method

You can set the tuning method. You can select the received stations in channel no. order or in channel name order (alphabetic order).

1 Press and hold **F/SETUP for at least 3 seconds.**

2 Press **◀◀ or **▶▶** to select "CH NO" or "ALPHABET."**

3 Press **BAND/TEL. to set the tuning method.**

CH NO : Set in order of channel no. (Initial setting)

ALPHABET : Set in alphabetic order.

4 Press **F/SETUP to return to normal mode.**

- When the setting is completed, switch the channel DOWN/UP by pressing the **◀◀** or **▶▶**.

Setting the Auxiliary Data Field Display

The XM Auxiliary Data Field display can be switched on or off.

1 Press and hold **F/SETUP for at least 3 seconds.**

2 Select "ADF" (Auxiliary Data Field) by pressing **◀◀ or **▶▶**.**

3 Select ON/OFF by pressing **BAND/TEL.**

When setting to ON, Auxiliary Data Field is displayed by pressing **DISP/TITLE** . (Refer to the "Changing the Display" section on this page.)

4 Press **F/SETUP to return to normal mode.**

- The initial setting at the factory is ADF OFF.

Direct Channel Access

When using the optional remote control (RUE-4190), an XM Channel can be directly called up with the numeric keypad of the remote control.

1 While in XM Radio mode, enter the Channel number you want to call up with the numeric keypad on the remote control.

The channel number blinks in the display.

2 Press **ENTER or **+ 10/OK** on the remote control within 5 seconds to receive the XM Channel.**

If the channel number is 3 digits, the XM Channel is automatically received after the channel number is input.

- Pressing **RTN** on the remote control while inputting a channel number, a channel number returns you to the previous channel.
- If you make a mistake inputting a channel number; you can erase the entered digits one at a time with **DEL.** on the remote control within 5 seconds. To erase all current channel numbers, press and hold **DEL.** for at least 2 seconds.
- If you erase all channel number while "CH ---" is displayed, and no operation has been performed within 5 seconds, the Direct Channel Access mode closes.
- If there is no XM Channel after inputting channel number, "----" is displayed for 2 seconds and returns to the previously input channel number.
- If no operation has been performed for 5 seconds after inputting one or two digit channel number, the input channel number is received.

Radio

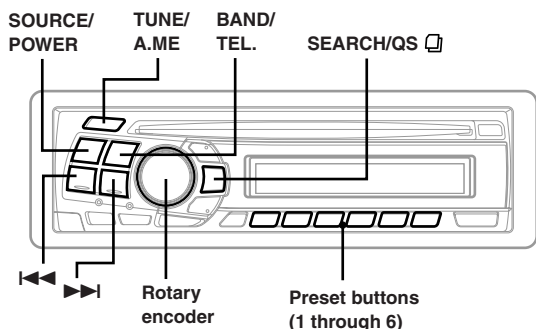

Listening to Radio

1 Press **SOURCE/POWER** until a radio frequency appears in the display.

2 Press **BAND/TEL.** repeatedly until the desired radio band is displayed.

F1 (FM1) → F2 (FM2) → AM → F1 (FM1)

3 Press **TUNE/A. ME** to select the tuning mode.

DX SEEK (Distance mode) → DX SEEK (Local mode) → DX SEEK(Manual mode)→ DX SEEK

- Only the portions underlined above are displayed.
- The initial mode is DX SEEK (Distance mode).

Distance mode:

Both strong and weak stations will be automatically tuned in (Automatic Seek Tuning).

Local mode:

Only strong stations will be automatically tuned in (Automatic Seek Tuning).

Manual mode:

The frequency is manually tuned in steps (Manual tuning).

4 Press **◀◀** or **▶▶** to tune in the desired station. Holding down **◀◀** or **▶▶** will change the frequency continuously.

- The **ST** indicator appears on the display when a stereo FM station is tuned in.

Manual Storing of Station Presets

1 Select the radio band and tune in a desired radio station you wish to store in the preset memory.

2 Press and hold any one of the **preset buttons (1 through 6)** that you want to store the station on for at least 2 seconds.

The selected station is stored.

The display shows the band, preset no. and station frequency memorized.

- A total of 18 stations can be stored in the preset memory (6 stations for each band; F1, F2 and AM).
- If you store a station in a preset memory which already has a station, the current station will be cleared and replaced with the new station.

Automatic Memory of Station Presets

1 Press **BAND/TEL.** repeatedly until the desired radio band is displayed.

2 Press and hold **TUNE/A. ME** for at least 2 seconds. The frequency on the display continues to change while the automatic memory is in progress. The tuner will automatically seek and store 6 strong stations in the selected band. They will be stored into buttons 1 to 6 in order of signal strength.

When the automatic memory has been completed, the tuner goes to the station stored in preset location no. 1.

- If no stations are stored, the tuner will return to the original station you were listening to before the auto memory procedure began.

Tuning to Preset Stations

1 Press **BAND/TEL.** repeatedly until the desired band is displayed.

2 Press any one of the station **preset buttons (1 through 6)** that has your desired radio station in memory.

The display shows the band, preset number and frequency of the station selected.

Station Title Search Function

If titles for radio stations are entered, you can search for a radio station from its title.

1 Press **SEARCH/QS** in Radio mode to switch to **Title Search mode.**

The first title input blinks in the display.

2 Select the desired title by turning the **Rotary encoder** within 10 seconds.

3 Press the **Rotary encoder** to receive the frequency of the selected title.

- Search mode in Title Search mode is canceled by pressing and holding **SEARCH/QS** for at least 2 seconds.
- If a station has no title, "NO TITLE" is displayed for 2 seconds.
- Any radio station can be searched by the Station Title Search function. The station titles are displayed in the order they were input.

Quick Search Function

You can search for a radio station by its frequency.

1 Press and hold **SEARCH/QS** for at least 2 seconds in Radio mode to activate Quick Search mode.

2 Turn the **Rotary encoder** within 10 seconds to select the desired frequency.

3 Press the **Rotary encoder** to receive the selected frequency.

- Search mode in Quick Search mode is canceled by pressing and holding **SEARCH/QS** for at least 2 seconds.

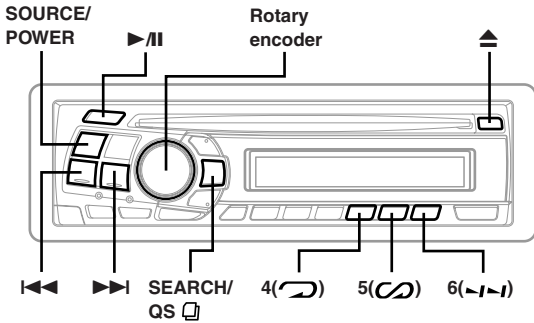

Playback

- 1 Insert a disc with the label side facing up.**
The disc will be pulled into the unit automatically.

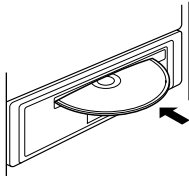

The CD player begins playback from the first track on the disc. When a disc is already inserted, press SOURCE/POWER to switch to the CD mode.

The mode will change every time the button is pressed.

TUNER → XM → CD → CD CHANGER* → TUNER

* Only when the CD changer is connected

- 2 Press ◀◀ or ▶▶ to select the desired track.**

Returning to the beginning of the current track:
Press ◀◀.

Fast backward :
Press and hold ◀◀.

Advancing to the beginning of the next track:
Press ▶▶.

Fast forward :
Press and hold ▶▶.

- 3 To pause playback, press ▶/||.**
Pressing ▶/|| again will resume playback.

- 4 To eject the disc, press ▲.**

- Do not remove a CD during its eject cycle. Do not load more than one disc at a time. A malfunction may result from doing either.
- Three-inch (8cm) CD's can be used.
- If the CD is not removed for 15 seconds after it has been ejected, the player automatically draws the CD into the compartment to protect the CD.

Repeat Play

Press 4 (↺) to play back repeatedly the track being played.

The track will be played repeatedly.

Press 4 (↺) again and select OFF to deactivate repeat play.

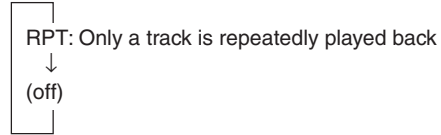

M.I.X. (Random Play)

Press 5 (↻) in the play or pause mode.

The tracks on the disc will be played back in random sequence.

To cancel M.I.X. play, press 5 (↻) again.

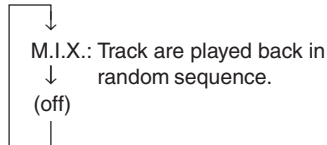

- A disc that contains more than 40 tracks may not be correctly played back with the M.I.X. function.

Scanning Programs

Press 6 (↵) to activate the Scan mode.

The first 10 seconds of each track will be played back in succession.

To stop scanning, press 6 (↵) and deactivate the Scan mode.

Track Search

You can search for tracks.

- 1 Press SEARCH/QS (🔍) in the CD mode to activate Track Search mode.**
- 2 Select a desired track by turning the Rotary encoder within 10 seconds.**
- 3 Press the Rotary encoder to play back the selected track.**

- Search mode in Track Search mode is canceled by pressing and holding SEARCH/QS (🔍) for at least 2 seconds.

Quick Search

You can search for tracks.

- 1 Press and hold SEARCH/QS (🔍) for at least 2 seconds in the CD mode to activate Quick Search mode.**
 - 2 Turn the Rotary encoder within 10 seconds to select a desired track.**
The selected track is played back immediately.
- Search mode is canceled by pressing and holding SEARCH/QS (🔍) for at least 2 seconds in Quick Search mode.

Sound Setting

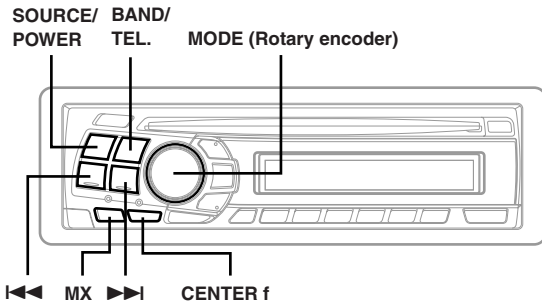

Adjusting Balance (Between Left and Right)/Fader (Between Front and Rear)/Defeat

1 Press **MODE (Rotary encoder)** repeatedly to choose the desired mode.

Each press changes the modes as follows:

SUBWOOFER*¹ → BALANCE → FADER → DEFEAT → VOLUME → SUBWOOFER*¹

Subwoofer : 0 ~ +15
 Balance : L15 ~ R15
 Fader : R15 ~ F15
 Defeat : ON/OFF
 Volume : 0 ~ 35

- If the **MODE (Rotary encoder)** is not pressed within 5 seconds after selecting the **BALANCE, FADER, DEFEAT** or **SUBWOOFER** mode, the unit automatically returns to normal mode.

*¹ When the subwoofer mode is set to OFF, its level cannot be adjusted.

2 Turn the **Rotary encoder** until the desired sound is obtained in each mode.

By setting Defeat ON, previously adjusted settings of BASS and TREBLE will return to the factory defaults and MX is turned off.

- Depending on the connected devices, some functions and display indications do not work.

Setting the Bass Control

You can change the bass frequency emphasis to create your own tonal preference.

1 Press **CENTER f** to select the Bass (bass center frequency) Control mode.

BASS → TREBLE → normal mode → BASS

2-1*² Setting the bass center frequency: Press **◀** or **▶** to select the desired bass center frequency.

60Hz ↔ 80Hz ↔ 100Hz ↔ 200Hz ↔ 60Hz

The displayed bass frequency is emphasized.

2-2*² Setting the bass band width (Q-Factor): Press **BAND/TEL.** to select the desired bass band width.

→ B. Width1 → B. Width2 → B. Width3 → B. Width4
 (Narrow) ← → (Wide)

Changes the boosted bass band width to wide or narrow. A wide setting will boost a wide range of frequencies above and below the center frequency. A narrower setting will boost only frequencies near the center frequency.

2-3 Setting the bass level: Turn the **Rotary encoder** to select the desired bass level (-7~+7).

You can emphasize or weaken the bass frequency.

- If no buttons are pressed within 15 seconds, the bass control setting will be turned off automatically.
- The bass level settings will be individually memorized for each source (FM, AM, XM, CD, etc.) until the setting is changed. The bass frequency and bass band width settings adjusted for one source are effective for all other sources (FM, AM, XM, CD etc.).
- Depending on the connected devices, some functions and display indications do not work. However, bass level is still adjustable if an audio processor with the bass adjustment is connected.
- This function is inoperable when DEFEAT is set to ON.

*² Selecting any of the "Setting the Bass Type" (TYPE 1 through 3), temporarily replaces the custom settings you have made above.

Setting the Treble Control

You can change the Treble Frequency emphasis to create your own tonal preference.

1 Press **CENTER f** to select the Treble (treble center frequency) Control mode.

BASS → TREBLE → normal mode → BASS

2-1 Setting the treble Center frequency: Press **◀◀** or **▶▶** to select the desired treble center frequency.

10.0kHz ↔ 12.5kHz ↔ 15.0kHz ↔ 17.5kHz ↔ 10.0kHz

The displayed Treble frequency is emphasized.

2-2 Setting the treble level: Turn the **Rotary encoder** to select the desired treble level (-7~+7).

You can emphasize the treble frequency.

- If no buttons are pressed within 15 seconds, the treble control setting will be turned off automatically.
- The treble level settings will be individually memorized for each source (FM, AM, XM, CD, etc.) until the setting is changed. The Treble frequency settings adjusted for one source are effective for all other sources (FM, AM, XM, CD, etc.).
- Depending on the connected devices, some functions and display indications do not work. However, treble level is still adjustable if an audio processor with the treble adjustment is connected.
- This function is inoperable when DEFEAT is set to ON.

Setting the Bass Type

This function allows for 3 different bass type settings. Select the one that appeals to you the most.

1 Press and hold **CENTER f** for at least 2 seconds to set the bass type.

2 Press **◀◀** or **▶▶** within 15 seconds to select the desired type (1 through 3).

TYPE 1 will sound best if you have a subwoofer in your system. Use TYPE 2 or 3 if you are using small diameter speakers.

3 Press and hold **CENTER f** for at least 2 seconds to return to normal mode.

- Bass center frequency and bass band width previously set are replaced when selecting TYPE 1 through 3. When bass type is set to OFF, your previous settings are restored.
- Bass type is not selectable when connected to an external audio processor.

Setting the MX Mode

MX (Media Xpander) makes vocals or instruments sound distinct regardless of the music source. The radio, CD, and MP3 (when an MP3 compatible CD changer is connected) will be able to reproduce the music clearly even in cars with a lot of road noise.

1 Press **MX** to select MX ON.

2 Press **SOURCE/POWER** to select the source to which you want to apply MX (Media Xpander).

3 Press and hold **MX** for at least 2 seconds to activate the level setting mode.

4 Turn the **Rotary encoder** to select your preferred level or OFF.

FM (MX level 1 to 3):

The medium to high frequencies become clearer, and produces well balanced sound at all frequencies.

CD (MX level 1 to 3):

CD mode processes a large amount of data during playback. MX takes advantage of this large data quantity to reproduce a more clear, clean output.

MP3/XM (MX level 1 to 3):

This corrects information that was lost at the time of compression. This reproduces a well-balanced sound close to the original.

DVD (Video CD)

(MOVIE MX level 1 to 2):

The dialog portion of a video is reproduced more clearly.

(MUSIC MX level 1):

A DVD or Video CD contains a large quantity of data such as music clip. MX uses this data to reproduce the sound accurately.

AUX (MX level 1):

Choose the MX mode (MP3, MUSIC, or MOVIE) that corresponds to the media connected.

If two external devices are connected, a different MX mode for each media can be selected.

5 Press **Rotary encoder** to return to normal mode.

- By "Setting Tone Defeat for External Devices" (page 16) to ON, operation is bypassed.
- To cancel MX mode for all music sources, press MX to turn MX off.
- MX mode is automatically canceled if no buttons are pressed within 15 seconds.
- Each music source, such as radio, CD, and MP3 (when an MP3 compatible CD changer is connected) can have its own MX setting.
- If an MP3 compatible CD changer is connected, on disks with both MP3 and CD-DA, when the source changes from "MP3 to CD-DA" or "CD-DA to MP3," MX-mode switching may delay playback slightly.
- Setting to MX OFF sets MX mode of each music source to OFF.
- This function is inoperable when DEFEAT is set to ON.
- There is no MX mode for AM radio.
- If an audio processor with the MX function (PXA-H700, etc.) is connected, its own MX processing is applied to the music source. Since the processor MX settings may not match the head unit, the audio processor needs to be adjusted. For details, refer to the Owner's Manual of the audio processor.

Other Functions

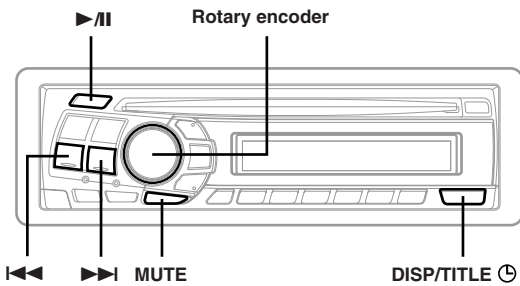

Displaying the Title/Text

It is possible to display the CD/Station title if the title has been previously inputted (“Titling Disc/Stations” page 14). If a CD text compatible CD changer is connected, text information, such as the disc name and the track name, will be displayed while playing a CD text compatible disc. If an MP3 compatible CD changer is connected, it is also possible to display the folder name, the file name, and the tag, etc., while playing MP3 files.

Press **DISP/TITLE**

The display will change every time the button is pressed.

The display in Radio mode:

FREQUENCY → CLOCK → TITLE → FREQUENCY

The display in CD/Changer mode:

TRACK NO./ELAPSED TIME → TRACK NO./CLOCK → TEXT (DISC NAME)*¹ → TEXT (TRACK NAME)*¹ → TITLE → TRACK NO./ELAPSED TIME

The display in XM Radio mode:

Channel Number*² → Channel Name → Song Title → Artist Name → Auxiliary Data Field*³ → Clock → Channel Number*²

The display in MP3 Changer mode:

FILE NO./ELAPSED TIME → FOLDER NO./FILE NO. → FILE NO./CLOCK → FOLDER NAME → FILE NAME → TRACK NAME*⁴ → ARTIST NAME*⁴ → ALBUM NAME *⁴ → FRAME*⁵ → FILE NO./ELAPSED TIME.

- *¹ Displayed during playback of a disc with CD Text, if a CD text compatible CD changer is connected.
“NO TEXT” will be displayed when the CD contains no Text data.
- *² The Channel Name display automatically changes after a few seconds.
- *³ When ADF is turned OFF, this information is not displayed (see “Setting the Auxiliary Data Field Display” page 8).
- *⁴ ID3 tag
If an MP3 file contains ID3 tag information, all the ID3 tag information is displayed (e.g., track name, artist name, and album name). All other tag data is ignored.
“NO DATA” will be displayed when an MP3 file contains no ID3 tag information.
Up to 30 characters can be displayed for the ID3 tag.
- *⁵ The recording sampling rate and bit rate of the MP3 file are displayed.

About the indicator display

When displaying Title/Text, the following indicators are lit according to the mode.

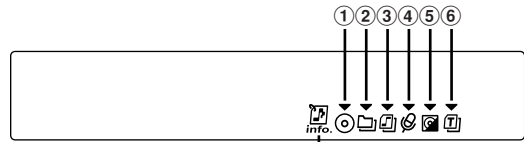

This indicator is constantly lit.

Indicator/ Mode	CD Mode	MP3 Mode* ²	TUNER Mode	XM RADIO Mode
①	Title being displayed	—	—	—
②	—	Folder Name being displayed	—	—
③	—	File Name being displayed	—	—
④	—	Artist Name being displayed* ³	—	Artist Name being displayed
⑤	Text (Disc Name) being displayed ¹	Album Name being displayed* ³	—	—
⑥	Text (Track Name) being displayed ¹	Track Name being displayed* ³	Title being displayed	Song Title/ Channel Name being displayed

*¹ When CD text compatible CD changer is connected.

*² When MP3 compatible CD changer is connected.

*³ Tag information

About “Title” and “Text”

Title:

With this device, it is possible to input the CD/Station name (page 14). This inputted name is referred to as a “title.” You cannot input or display titles on MP3 discs and XM Radio Channel.



Text:

Text compatible CDs contain text information such as the disc name and track name. Such text information is referred to as “text.”

- Some characters may not be displayed correctly with this device, depending on the character type.
- The CD changer must also be CD Text compatible for the Text information to be displayed.
- When the Scroll Setting (page 15) is set to “SCR MANU,” press and hold **DISP/TITLE** for at least 3 seconds to scroll the Text information only once.
CHANGER mode : TEXT DISPLAY, FOLDER NAME DISPLAY, FILE NAME DISPLAY or TAG DISPLAY mode
XM RADIO mode : CHANNEL NAME DISPLAY, SONG TITLE DISPLAY, ARTIST NAME DISPLAY or ADF DISPLAY mode
- “NO SUPRT” is displayed when the desired text information cannot be displayed on this unit to which an MP3 compatible CD changer is connected.
- If the title was not previously input, “NO TITLE” is displayed.
- The text or tag information may not be correctly displayed, depending on the contents.

Titling Discs/Stations







It is possible to title your favorite CD's or radio stations.
You cannot input titles on MP3 discs (when an MP3 compatible CD changer is connected) and XM Radio Channel.

- 1 Press DISP/TITLE  and select the Title Display.**
For details, see "Displaying the Title/Text" (page 13).
- 2 Press and hold DISP/TITLE  for at least 3 seconds.**
The first character will blink.
- 3 Turn the Rotary encoder to select the desired letter/numeral/symbol available for naming.**
- 4 Press Rotary encoder to store the first character.**
The first character will stop blinking and the display will automatically advance to the next character. When that character begins to blink, you may choose the next letter or symbol of your title.
- 5 Repeat steps 3 and 4 above to complete the titling.**
Pressing the Rotary encoder after entering the 8th character automatically stores the title into memory.

When entering a title of less than 8 characters (for example, 3 character title):
After entering 3 characters, the 4th character space will be blinking. Go to step 6 to complete the title.
- 6 Press DISP/TITLE  to record the title.**

- If you cancel while entering a title, selected characters are not written.
- You can enter 18 radio station titles and 18 CD titles on this unit. If you try to store beyond the limit, the display will show "FULL DATA." At this point, no more titles can be stored. To input a new title, one of the previously inputted titles must first be deleted.
- The CD Changer title length or memory capacity varies depending upon the model being used.
- When you want to erase a title, enter the " " symbol into all spaces.
- The operations described in steps 3 to 5 must be made within 10 seconds. The input mode will be canceled if no action is taken for over 10 seconds.

Erasing Disc Title/Station Title

- 1 Press DISP/TITLE  to select the Title Display.**
Then, press again and hold for at least 3 seconds.
 - 2 Within 10 seconds, press and hold  for at least 2 seconds.**
The title in the display will blink.
 - 3 Press  or  repeatedly until the title you want to erase is displayed.**
 - 4 Press and hold  for at least 2 seconds to erase the title displayed.**
 - 5 Press DISP/TITLE  to cancel the title erasing mode.**
- You cannot erase CD-TEXT.
 - "NO DATA" is displayed for 2 seconds if the title is not input in step 2, or if all titles are erased in step 4.

Displaying Time

Press DISP/TITLE  repeatedly until the time is displayed.

Each press changes the display.
For details, see "Displaying the Title/Text" (page 13).

- Selecting any tuner, XM radio or CD function while in the clock priority mode will interrupt the time display momentarily. The function selected will be displayed for about 5 seconds before the time returns to the display. However, if the channel number is changed in the XM radio mode, the channel number is displayed for a few seconds, and then the time display returns.
- When the power is off but the ignition key is on, press **DISP/TITLE ** to display the time.

Blackout Mode On and Off

When Blackout mode is turned on, the display will turn off to reduce power consumption. This additional power enhances the sound quality.

Press and hold MUTE for at least 3 seconds to activate the blackout mode.

The display will turn off.

- If any button on the unit is pressed during the blackout mode, the function will be displayed for 5 seconds to show the operation before returning to Blackout mode.

To cancel Blackout mode, press and hold MUTE for at least 3 seconds.

SETUP

You can flexibly customize the unit to suit your own preferences and usage. Choose the SETUP menu from General Customizing, External Device, to select your desired setting.

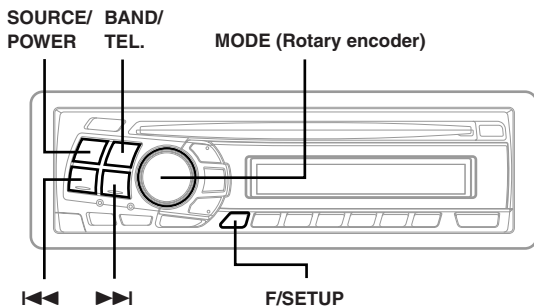

The common operation for SETUP is step 1 to 4 as follows. See down below for further information about each SETUP menu.

1 Press and hold F/SETUP for at least 3 seconds.
SETUP mode is activated.

2 Press ◀◀ or ▶▶ to select the desired SETUP menu.
(e.g. Select SUBW (Subwoofer))

SUBW → CD-DA / CD/MP3*¹ → SCR → MUTE → INT → AUX → (AUX name)*² → PWR → TEL*³ → CH NO/ALPHABET → ADF → SUBW

*¹ CD-DA/CD/MP3 is displayed when an MP3 compatible CD changer is connected. Refer to "Playing MP3 Data" on page 18.

*² Displayed only when AUX is ON.

*³ TEL is displayed when the Alpine MobileHub is connected. Refer to "Setting the Automatic Calling" on page 19.

3 Press BAND/TEL. to change the setting.
(e.g. Select SUBW ON or SUBW OFF.)

4 Press F/SETUP again.
The display returns to normal mode.

General Customizing

Subwoofer On and Off SUBW ON (Initial setting) / SUBW OFF

When the subwoofer is on, perform the steps below to adjust the subwoofer output level.

1 Press the MODE (Rotary encoder) repeatedly to select the SUBW mode.

SUBW* → BALANCE → FADER → DEFEAT → VOLUME → SUBW

* Displayed when Subwoofer is set to ON.

2 Turn the Rotary encoder until the desired sound is obtained.

Scroll Setting

SCR AUTO / SCR MANU (Initial setting)

This XM Radio can scroll the channel name, category, artist, and song title. If connected with a CD text compatible CD changer or MP3 compatible CD changer, this unit can scroll the disc and track names recorded on CD-TEXT discs, as well as the text information of MP3 files, folder names, and ID3 tags.

SCR AUTO : Channel name, category, artist and song title (XM Radio), and CD text information, the text information of folder and file names, and ID3 tags are scrolled automatically.
SCR MANU : The display is scrolled only when a disc is loaded or when a track is changed, etc.

- The disc titles input manually (page 14) cannot be scrolled.

External Device

Turning Mute Mode On/Off

MUTE ON (Initial setting) / MUTE OFF

If a device having the interrupt feature is connected, audio will be automatically muted whenever the interrupt signal is received from the device.

Setting the AUX Mode (V-Link)

AUX ON / AUX OFF (Initial setting)

You can input TV/video sound by connecting an optional Ai-NET/ RCA Interface cable (KCA-121B) or Versatile Link Terminal (KCA-410C) to this component.

You can change the AUX name display when AUX ON is set. Select the AUX name by pressing ◀◀ or ▶▶. Then press BAND/TEL. If the KCA-410C is connected, it is possible to select two AUX names.

- Via KCA-410C, up to 2 external devices with RCA output can be connected. In this case, press SOURCE/POWER to select AUX mode and then press BAND/TEL. to select your desired device.

Connecting to an External Amplifier

PWR ON (Initial setting) / PWR OFF

When an external amplifier is connected, sound quality can be improved by stopping the power supply of the built-in amplifier.

PWR OFF : Use this mode when the front and rear pre-amplifier of the unit are used to drive an external amplifier connected to the speakers. In this setting, the head unit's internal amplifier has no output to drive speakers.

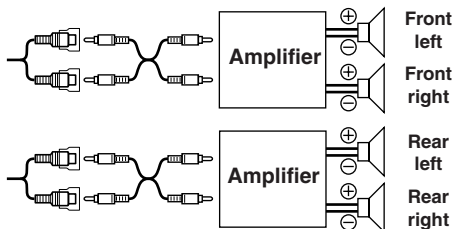

PWR ON : The speakers are driven by the built-in amplifier.

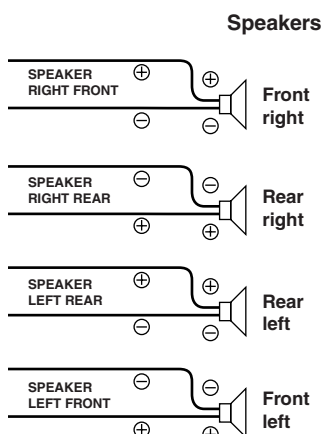

- No sound is produced by the system when the power output is set to OFF.

Setting Tone Defeat for External Devices

INT ON / INT OFF (Initial setting)

When inputting external devices to this unit, turning tone defeat on will bypass BASS, TREBLE and MX, i.e., sound for external devices is output at the default setting.

Changer (Optional)

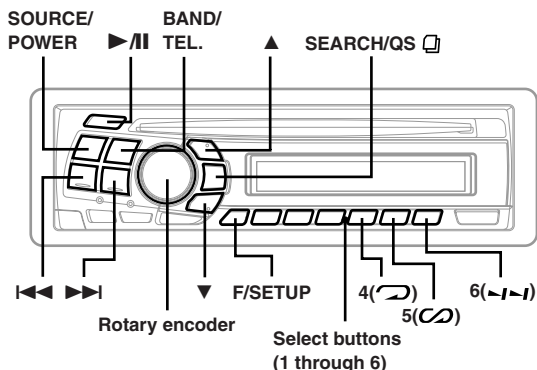

Controlling CD Changer (Optional)

An optional 6-disc or 12-disc CD Changer may be connected to this unit if it is Ai-NET compatible. With a CD Changer connected to the Ai-NET input of this unit, the CD Changer will be controllable from this unit.

Using the KCA-400C (Multi-Changer Switching device) or the KCA-410C (Versatile Link Terminal) multiple changers can be controlled by this unit.

See "Multi-Changer Selection" on page 17 for selecting the CD Changers.

- The controls on this unit for CD Changer operation are operative only when a CD Changer is connected.
- The DVD changer (optional) is controllable from this unit as well as the CD changer.

1 Press SOURCE/POWER to activate the CHANGER mode.

The display shows the disc number and track number.

- The source indicator varies depending on the connected source.
- Press BAND/TEL. to switch the Disc mode in the CD/Changer mode.

2 Press the disc select buttons (1 through 6) corresponding to one of the discs loaded in the CD Changer.

The selected disc number appears in the display and CD playback starts.

- After selecting the desired disc, you can operate in the same way as for the CD player of this unit.
For details, please see the CD section.
- If the underlined portion of the "FUNC" indicator is illuminated, the disc select buttons become nonfunctional.

When a 12-disc CD Changer is connected:

To select discs numbered from 1 to 6, the procedure is the same as for the 6-disc CD Changer. To select discs numbered from 7 to 12, first press F/SETUP. This changes the "D" indicator to "d." Then press the desired preset button. With F/SETUP activated, the preset buttons 1 to 6 will represent discs 7 to 12 respectively.

Playing MP3 Files with the CD Changer (Optional)

If you connect a changer compatible with MP3, you can play CD-ROMs, CD-Rs, and CD-RWs containing MP3 files on this unit.

- 1 Press **SOURCE/POWER** to switch to the MP3 Changer mode.
- 2 Press any one of the disc select buttons (1 through 6) corresponding to one of the discs loaded in the CD Changer.
The selected disc number appears in the display and MP3 files playback starts.
- 3 Press **◀◀** or **▶▶** to select the desired track (file).

Returning to the beginning of the current track (file):

Press **◀◀**.

Fast backward :

Press and hold **◀◀**.

Advancing to the beginning of the next track (file) :

Press **▶▶**.

Fast forward :

Press and hold **▶▶**.

- 4 To pause playback, press **▶/II**.

Pressing **▶/II** again will resume playback.

- The unit can play discs containing both audio data and MP3 data.
- The track display for MP3 data playback is the file numbers recorded on the disc.
- While playing back MP3, press **▲** or **▼** to move the folder up or down.
- The root folder appears as 1 in the folder number display. Therefore, the first folder appears as 2.

Multi-Changer Selection (Optional)

Alpine's Ai-NET system will support up to 6 CD Changers. When operating two or more changers, the KCA-400C (Multi-Changer Switching device) must be used. If you use 1 Switching device, you can connect up to 4 CD Changers. If you use 2 Switching devices, you can connect up to 6 CD Changers. When using KCA-410C (Versatile Link Terminal), you can connect two changers and two external outputs (AUX).

- 1 Press **SOURCE/POWER** on this unit to activate the CD Changer mode.

Alternatively, press **SOURCE** on the remote control (optional) to activate the CD changer mode.

- 2 Press **BAND/TEL.** on this unit to activate the CD Changer Selection mode.

The CD Changer Selection mode remains active for 8 seconds.

Alternatively, press **BAND** on the remote control (optional) to activate the CD changer selection mode.

- 3 Press **BAND/TEL.** until the desired CD Changer indicator appears on the display.

Alternatively, press **BAND** on the remote control (optional) until the desired changer indicator appears on the display.

- If the selected CD Changer is not connected, the display will show "NO CHGR."
- To operate the selected changer, see "CD" (page 10).
- For further details about the external input (AUX) when using KCA-410C, see "Setting the AUX Mode (V-Link)" on page 15.

Repeat Play

- 1 Press **F/SETUP** to illuminate the underlined portions of the "FUNC" indicator, and go to step above within 5 seconds.

- 2 Press **4** (↺) to play back repeatedly the track being played.

The track (file) will be played repeatedly.

Press **4** (↺) again and select OFF to deactivate repeat play.

CD mode :

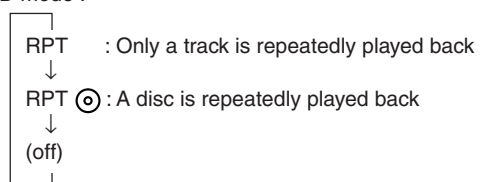

- When the Repeat ALL mode is selected, the unit repeatedly plays back all tracks on the disc selected.
- If REPEAT is set to ON during M.I.X. play in CD changer mode, M.I.X. will apply to the current disc only.

MP3 mode :

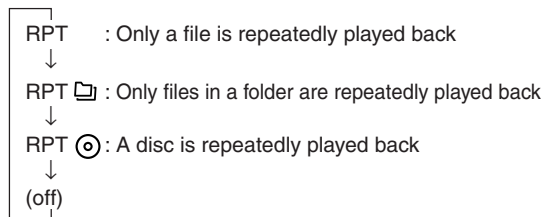

M.I.X. (Random Play)

- 1 Press **F/SETUP** to illuminate the underlined portions of the "FUNC" indicator, and go to step above within 5 seconds.

- 2 Press **5** (∞) in the play or pause mode.

The tracks (files) on the disc will be played back in random sequence.

To cancel M.I.X. play, press **5** (∞) again.

CD mode :

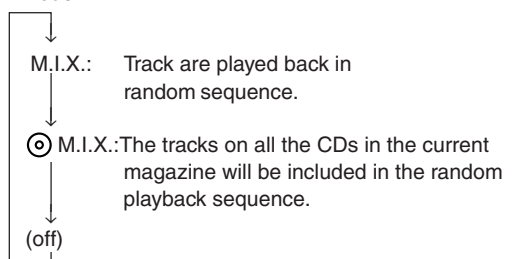

- If M.I.X. is set to ON during RPT  (REPEAT ALL) play in CD changer mode, M.I.X. will apply to the current disc only.

MP3 mode :

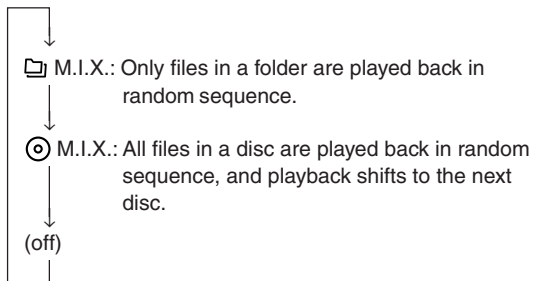

Scanning Programs

1 Press F/SETUP to illuminate the underlined portions of the “FUNC” indicator, and go to step above within 5 seconds.

2 Press 6 (↵) to activate the Scan mode.

The first 10 seconds of each track (file) will be played back in succession.

To stop scanning, press 6 (↵) and deactivate the Scan mode.

Track Search

When a CD text compatible CD changer is connected, you can search for tracks from its text to select the next track. For a non-CD text disc, you can search by track.

1 Press SEARCH/QS  to activate Track Search mode.

2 Select a desired track by turning the Rotary encoder within 10 seconds.

3 Press the Rotary encoder to play back the selected track.

- Search mode in Track Search mode is canceled by pressing and holding SEARCH/QS  for at least 2 seconds.
- A track can be searched from the currently playing disc by CD text or track.

File/Folder Search (only for MP3 compatible changer)



1 Press SEARCH/QS  to select File Search mode or Folder Search mode.

File Search mode

2 Press ▲ or ▼ to select another Folder.

3 Select the desired file by turning the Rotary encoder within 10 seconds.



4 Press the Rotary encoder to play back the selected file.

- File Search mode is canceled by pressing and holding SEARCH/QS  for at least 2 seconds.
- While in File Search mode, press SEARCH/QS  to switch to Folder Search mode.

Folder Search mode

2 Turn the Rotary encoder within 10 seconds to select the desired folder.

3 Press the Rotary encoder to play back the first file in the selected folder.

- Search mode is canceled by pressing and holding SEARCH/QS  for at least 2 seconds in Folder Search mode.
- While in Folder Search mode, press SEARCH/QS  to switch to File Search mode.
- "NO FILE" is displayed for 2 seconds if the folder that is selected by the Folder Search mode contains no files.

Quick Search

You can search for tracks(files).

1 Press and hold SEARCH/QS  for at least 2 seconds to activate Quick Search mode.

2 Turn the Rotary encoder within 10 seconds to select a desired track(file).

The selected track is played back immediately.

- Search mode is canceled by pressing and holding SEARCH/QS  for at least 2 seconds in Quick Search mode.
- A track can be searched from the currently playing disc by track.

Playing MP3 Data

When an MP3 compatible CD changer is connected, you can playback CDs containing both CD and MP3 data. However, in some situations (some enhanced CDs), playback may be difficult. For these special cases, you can select playback of CD data only. When a disc contains both CD or the MP3 data, playback starts from the CD data portion of the disc.

1 Press and hold F/SETUP for at least 3 seconds.

2 Press ◀◀ or ▶▶ to select “CD-DA” or “CD/MP3.”

3 Press BAND/TEL. to set the tuning method.

CD-DA : Only CD data can be played back.

CD/MP3 : Both CD data and MP3 file tracks can be played back.

4 Press F/SETUP to return to normal mode.

- When the above setting has been completed, you need to change discs in the MP3 changer.
- When the MP3 changer is not connected, you do not need to perform this setting.

MobileHub™ Link Operation(Optional)

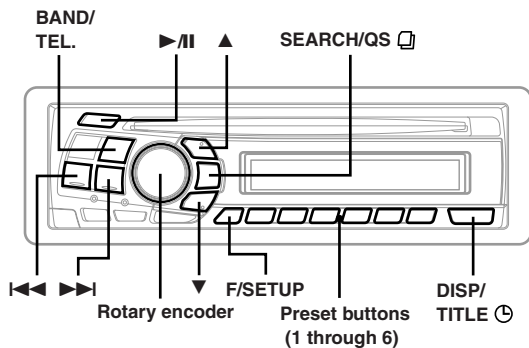

About MobileHub™ Link

Connect a separately sold junction box and a portable telephone (available from Nokia) to control the incoming and outgoing calls of the portable telephone.

Caution

Even with hands-free operation, a driver can be distracted during telephone operation or receiving a call. For the sake of safety, drivers are requested to refrain from operating the telephone while driving.

For the sake of safety, only incoming calls and Speed-Dial outgoing calls can be operated.

- If a portable telephone is connected, its address book, incoming and outgoing history are downloaded to the junction box.
- Please refer to the instruction manual of the junction box.

Telephone Mode ON/OFF

- 1 Press and hold **BAND/TEL.** for at least 2 seconds to turn on the Telephone mode.

To turn off, press **BAND/TEL.**

See relevant pages for each item.

- Press and hold **BAND/TEL.** for at least 2 seconds. If a portable telephone is not connected, "NO PHONE" is displayed for about 2 seconds, then the mode returns to the original source mode.
- When the portable telephone is taken off the junction box during an incoming or outgoing call, or during a hands-free call, the call will be treated as an ordinary one by the portable telephone.
- When there is an incoming call while the power of CDA-9820XM is off, the power of CDA-9820XM will turn on automatically for a hands-free call.
- Even if the power of the portable telephone is off, when CDA-9820XM is set to Telephone mode, the power of the portable telephone will be turned on.
- Even if the ACC power of the vehicle is turned off (even if the engine is stopped) during a hands-free call, the call is not disconnected, and an ordinary call by the portable telephone is possible.
- If there is an incoming call during operation (except an outgoing call or talking), operation mode will end and switch to the incoming or talking mode.

- An outgoing call from a portable telephone is also possible. However, you cannot perform different operations at the same time from a portable telephone and CDA-9820XM as malfunction can result.
- With a junction box connected outgoing, incoming, and sending history will also be recorded in the portable telephone.
- While telephoning, defeat is set to ON. When the call has finished, the unit returns to your previous setting.
- The telephone volume can be adjusted on the CDA-9820XM. The volume you set during the call is memorized, and is automatically applied again on the next call.
- While telephoning or receiving incoming calls, press **DISP/TITLE** to show the Network Operator display for 5 seconds.

Incoming Calls

- 1 Press **▶/II** to receive an incoming call.
 - 2 Press **BAND/TEL.** to finish a call.
Telephone mode will end and return to the original source mode.
- When the Automatic Calling mode is on, you can talk after 3 seconds of receiving the incoming call. (see "Setting the Automatic Calling" on this page.)

Setting the Automatic Calling

The incoming call can be switched to Automatic Calling or Manual Calling.

- 1 Press and hold **F/SETUP** for at least 3 seconds.
- 2 Select the TEL mode by pressing **◀◀** or **▶▶**.
- 3 Press **BAND/TEL.** to change to TEL AUTO or TEL MANU.
- 4 Press **F/SETUP** to return to normal.

- Press **BAND/TEL.** during an incoming call to disconnect it.
- The initial setting of the factory is TEL MANU.

Calling

Calling by the address book

You can call up the address book registered in the portable telephone to call from.

- 1 Press and hold **BAND/TEL.** for at least 2 seconds.
- 2 Press **SEARCH/QS** to select PHONE BK (Phone Book) mode.
A list in alphabetic order is displayed.

Retrieving an addressee by Alphabetic Sort List

- 3 When displaying the Alphabetic Sort List, turn the **Rotary encoder** or press **◀◀** or **▶▶** to select the addressee.
- 4 Press **▶/II** or **Rotary encoder** to place a call.
- 5 Press **BAND/TEL.** to end the call.
Telephone mode will end and return to the original source mode.

Retrieving an addressee by Selecting Search (A-Z search)

- Press **▲** or **▼** to select an initial letter (A to Z) of the addressee.
 - Turn the **Rotary encoder** to select the addressee.
 - Press **▶/II** or **Rotary encoder** to place a call.
 - Press **BAND/TEL.** to end the call.
Telephone mode will end and return to the original source mode.
- If all telephone numbers and registered names cannot be displayed at once, press **DISP/TITLE**  to show undisplayed numbers and names.
 - "NO MEM" is displayed if nothing is registered in the Phone Book.



Calling by using the Speed Dial

You can place a call by retrieving one of the telephone numbers registered in No. 1 to 9 of the address book.

- Press and hold **BAND/TEL.** for at least 2 seconds.
 - Within 5 seconds, place a call by pressing and holding the desired **preset buttons (1 through 6)** for at least 2 seconds.
By pressing **F/SETUP**, and then pressing a **preset button (1 through 3)** for at least 2 seconds, you can place a call to the number registered in 7 to 9.
- You can place a call by pressing **▶/II** after momentarily pressing the **preset button (1 through 6)** of the number you wish to call.
 - You can place a call by pressing the **Rotary encoder**, after selecting a number which you wish to call, by pressing **◀◀** or **▶▶**, or by turning the **Rotary encoder**.
- Press **BAND/TEL.** to end the call.
Telephone mode will end and return to the original source mode.
- If there is no telephone number registered to a preset button, "NO P-SET" is displayed when you try to place a call.

Calling by the outgoing/incoming/absent incoming history

You can place a call to any of the last 999 calls by the outgoing/incoming/absent incoming history.

- Press **SEARCH/QS**  in **PHONE BK (Phone Book)** mode to select the History mode.
 - Press **▲** or **▼** to select outgoing history (display example: "DIALED"), incoming history (display example: "RECEIVED"), absent incoming history (display example: "MISSED").
 - Turn the **Rotary encoder**, or press **◀◀** or **▶▶** to select the addressee from the outgoing or incoming history.
 - Press **▶/II** or the **Rotary encoder** to place a call.
 - Press **BAND/TEL.** to end the call.
Telephone mode will end and return to the original source mode.
- If all telephone numbers and registered names cannot be displayed at once, press **DISP/TITLE**  to show undisplayed numbers and names.
 - "NO MEM" is displayed if there is no incoming history.

SMS (Short Message Service) Operation

You can be informed when you receive a short message.

Receiving a short message

- When a text message is received, "NEW MSG" is indicated on the display.
The contents of the received message can only be read from the portable phone's display.
- Press any one of the buttons on the unit to cancel the display. The buttons that are pressed will enter the mode or will be activated.

Information

In Case of Difficulty

If you encounter a problem, please turn the power off, then on again. If the unit is still not functioning normally, please review the items in the following checklist. This guide will help you isolate the problem if the unit is at fault. Otherwise, make sure the rest of your system is properly connected or consult your authorized Alpine dealer.

Basic

No function or display.

- Vehicle's ignition is off.
 - If connected following instructions, the unit will not operate with the vehicle's ignition off.
- Improper power lead connections.
 - Check power lead connections.
- Blown fuse.
 - Check the fuse on the battery lead of the unit; replace with the proper value if necessary.
- Internal micro-computer malfunctioned due to interference noise etc.
 - Press the RESET switch with a ballpoint pen or other pointed article.

Radio

Unable to receive stations.

- No antenna or open connection in cable.
 - Make sure the antenna is properly connected; replace the antenna or cable if necessary.

Unable to tune stations in the seek mode.

- You are in a weak signal area.
 - Make sure the tuner is in the DX mode.
- If the area you are in is a primary signal area, the antenna may not be grounded and connected properly.
 - Check your antenna connections; make sure the antenna is properly grounded at its mounting location.
- The antenna may not be the proper length.
 - Make sure the antenna is fully extended; if broken, replace the antenna with a new one.

Broadcast is noisy.

- The antenna is not the proper length.
 - Extend the antenna fully; replace it if it is broken.
- The antenna is poorly grounded.
 - Make sure the antenna is grounded properly at its mounting location.

CD

CD Player/Changer not functioning.

- Out of operating temperature range +50°C (+120°F) for CD.
 - Allow the vehicle's interior (or trunk) temperature to cool.

CD playback sound is wavering.

- Moisture condensation in the CD Module.
 - Allow enough time for the condensation to evaporate (about 1 hour).

CD insertion not possible.

- A CD is already in the CD player.
 - Eject the CD and remove it.
- The CD is being improperly inserted.
 - Make sure the CD is being inserted following instructions in the CD Player Operation section.

Unable to fast forward or backward the CD.

- The CD has been damaged.
 - Eject the CD and discard it; using a damaged CD in your unit can cause damage to the mechanism.

CD playback sound skips due to vibration.

- Improper mounting of the unit.
 - Securely re-mount the unit.
- The disc is very dirty.
 - Clean the disc.
- The disc has scratches.
 - Change the disc.
- The pick-up lens is dirty.
 - Do not use a commercially available lens cleaner disc. Consult your nearest ALPINE dealer.

CD playback sound skips without vibration.

- The disc is dirty or scratched.
 - Clean the disc; damaged disc should be replaced.

Error displays (built-in CD player only)

- Mechanical error
 - Press . After the error indication disappears, insert the disc again. If the above-mentioned solution does not solve the problem, consult your nearest ALPINE dealer.

CD-R/CD-RW playback not possible

- Close session (finalization) has not been performed.
 - Perform finalization and attempt playback again.

MP3 (when an MP3 compatible CD changer is connected)

MP3 is not played back (for MP3 compatible CD Changer only).

- Writing error occurred. The CD format is not compatible.
 - Make sure the CD has been written in a supported format.

Indication for CD Player

HI TEMP

- Protective circuit is activated due to high temperature.
 - The indicator will disappear when the temperature returns to within operation range.

NO DISC

- No CD is inserted.
 - Insert a CD.

ERROR

- Mechanism error.
 - 1) Press the **▲** button and eject the CD.
If not ejecting, consult your Alpine dealer.
 - 2) When the error indication remains after ejecting, press the **▲** button again.
If the error indication still does not turn off after pressing the **▲** button for a few times, consult your Alpine dealer.
- *When "ERROR" is displayed:
If that the disc cannot be ejected by pressing **▲**, press the RESET switch (refer to page 6) and press **▲** again.
If the disc still cannot be ejected, consult your Alpine dealer.*

Indication for CD Changer

HI TEMP

- Protective circuit is activated due to high temperature.
 - The indicator will disappear when the temperature returns to within operation range.

ERROR - 01

- Malfunction in the CD Changer.
 - Consult your Alpine dealer. Press the magazine eject button and pull out the magazine.
Check the indication. Insert the magazine again.
If the magazine cannot be pulled out, consult your Alpine dealer.
- Magazine ejection not possible.
 - Press the magazine eject button. If the magazine does not eject, consult your Alpine dealer.

ERROR - 02

- A disc is left inside the CD Changer.
 - Press the eject button to activate the eject function. When the CD Changer finishes the eject function, insert an empty CD magazine into the CD Changer to receive the disc left inside the CD Changer.

NO MAGZN

- No magazine is loaded into the CD Changer.
 - Insert a magazine.

NO DISC

- No indicated disc.
 - Choose another disc.

Indication for XM Radio Mode

ANTENNA

- The XM antenna is not connected to this unit.
 - Check whether the XM antenna cable is attached securely to this unit.

UPDATING

- Radio is being updated with latest encryption code.
 - Wait until encryption code is being updated. Channels 0 and 1 should function normally.

NO SIGNAL

- XM signal is too weak at the current location.
 - Wait until the car reaches a location with a stronger signal.

LOADING

- Radio is acquiring audio or program information.
 - Wait until the radio has received the information.

OFF AIR

- The channel currently selected has stopped broadcasting.
 - Select another channel.

- The user has selected a channel number that does not exist or is not subscribed to.
 - The unit will revert back to the previously selected channel.
- There is no artist name/feature, song/program title, or additional information associated with the channel at that time.
 - No action needed.

Specifications

FM TUNER SECTION

Tuning Range	87.7 – 107.9 MHz
Mono Usable Sensitivity	9.3 dBf (0.8 μ V/75 ohms)
50 dB Quieting Sensitivity	13.5 dBf (1.3 μ V/75 ohms)
Alternate Channel Selectivity	80 dB
Signal-to-Noise Ratio	65 dB
Stereo Separation	35 dB
Capture Ratio	2.0 dB

AM TUNER SECTION

Tuning Range	530 – 1,710 kHz
Sensitivity (IEC Standard)	22.5 μ V/27 dB

XM TUNER SECTION

Signal-to-Noise Ratio	85 dB
Stereo Separation	75 dB
Usable Sensitivity	-98 dBm (Satellite) -95 dBm (Terrestrial)

CD PLAYER SECTION

Frequency Response	5 – 20,000 Hz (\pm 1 dB)
Wow & Flutter (% WRMS)	Below measurable limits
Total Harmonic Distortion	0.008% (at 1 kHz)
Dynamic Range	95 dB (at 1 kHz)
Signal-to-Noise Ratio	105 dB
Channel Separation	85 dB (at 1 kHz)

PICKUP

Wave length	795 nm
Laser power	CLASS I

GENERAL

Power Requirement	14.4 V DC (11–16 V allowable)
Power Output	18W RMS \times 4*
* Primary amplifier ratings per CEA-2006 Standard	
• Power output: measured at 4 Ohms and \leq 1% THD+N	
• S/N: 80 dBA (reference: 1 W into 4 Ohms)	
Maximum Pre-Output Voltage	2 V/10 k ohms
Bass	\pm 14 dB at 60 Hz
Treble	\pm 14 dB at 10 kHz
Weight	1.5 kg (3 lbs. 5 oz)

CHASSIS SIZE

Width	178 mm (7")
Height	50 mm (2")
Depth	160 mm (6-1/4")

NOSEPIECE SIZE

Width	170 mm (6-11/16")
Height	46 mm (1-13/16")
Depth	20 mm (25/32")

- Due to continuous product improvement, specifications and design are subject to change without notice.

Controls on Remote Control (Optional)

This unit can be controlled with an optional Alpine remote control. For details, consult your Alpine dealer.

Point the optional remote control transmitter at the remote control sensor.

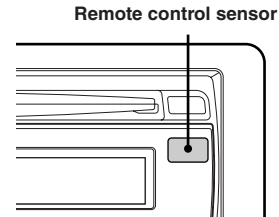

Installation and Connections

Before installing or connecting the unit, please read the following and pages 3 to 5 of this manual thoroughly for proper use.

Warning

MAKE THE CORRECT CONNECTIONS.

Failure to make the proper connections may result in fire or product damage.

USE ONLY IN CARS WITH A 12 VOLT NEGATIVE GROUND.

(Check with your dealer if you are not sure.) Failure to do so may result in fire, etc.

BEFORE WIRING, DISCONNECT THE CABLE FROM THE NEGATIVE BATTERY TERMINAL.

Failure to do so may result in electric shock or injury due to electrical shorts.

DO NOT ALLOW CABLES TO BECOME ENTANGLED IN SURROUNDING OBJECTS.

Arrange wiring and cables in compliance with the manual to prevent obstructions when driving. Cables or wiring that obstruct or hang up on places such as the steering wheel, gear lever, brake pedals, etc. can be extremely hazardous.

DO NOT SPLICE INTO ELECTRICAL CABLES.

Never cut away cable insulation to supply power to other equipment. Doing so will exceed the current carrying capacity of the wire and result in fire or electric shock.

DO NOT DAMAGE PIPE OR WIRING WHEN DRILLING HOLES.

When drilling holes in the chassis for installation, take precautions so as not to contact, damage or obstruct pipes, fuel lines, tanks or electrical wiring. Failure to take such precautions may result in fire.

DO NOT USE BOLTS OR NUTS IN THE BRAKE OR STEERING SYSTEMS TO MAKE GROUND CONNECTIONS.

Bolts or nuts used for the brake or steering systems (or any other safety-related system), or tanks should NEVER be used for installations or ground connections. Using such parts could disable control of the vehicle and cause fire etc.

KEEP SMALL OBJECTS SUCH AS BATTERIES OUT OF THE REACH OF CHILDREN.

Swallowing them may result in serious injury. If swallowed, consult a physician immediately.

DO NOT INSTALL IN LOCATIONS WHICH MIGHT HINDER VEHICLE OPERATION, SUCH AS THE STEERING WHEEL OR GEARSHIFT.

Doing so may obstruct forward vision or hamper movement etc. and results in serious accident.

Caution

HAVE THE WIRING AND INSTALLATION DONE BY EXPERTS.

The wiring and installation of this unit requires special technical skill and experience. To ensure safety, always contact the dealer where you purchased this product to have the work done.

USE SPECIFIED ACCESSORY PARTS AND INSTALL THEM SECURELY.

Be sure to use only the specified accessory parts. Use of other than designated parts may damage this unit internally or may not securely install the unit in place. This may cause parts to become loose resulting in hazards or product failure.

ARRANGE THE WIRING SO IT IS NOT CRIMPED OR PINCHED BY A SHARP METAL EDGE.

Route the cables and wiring away from moving parts (like the seat rails) or sharp or pointed edges. This will prevent crimping and damage to the wiring. If wiring passes through a hole in metal, use a rubber grommet to prevent the wire's insulation from being cut by the metal edge of the hole.

DO NOT INSTALL IN LOCATIONS WITH HIGH MOISTURE OR DUST.

Avoid installing the unit in locations with high incidence of moisture or dust. Moisture or dust that penetrates into this unit may result in product failure.

Precautions

- Be sure to disconnect the cable from the (-) battery post before installing your CDA-9820XM. This will reduce any chance of damage to the unit in case of a short-circuit.
- Be sure to connect the color coded leads according to the diagram. Incorrect connections may cause the unit to malfunction or damage to the vehicle's electrical system.
- When making connections to the vehicle's electrical system, be aware of the factory installed components (e.g. on-board computer). Do not tap into these leads to provide power for this unit. When connecting the CDA-9820XM to the fuse box, make sure the fuse for the intended circuit of the CDA-9820XM has the appropriate amperage. Failure to do so may result in damage to the unit and/or the vehicle. When in doubt, consult your ALPINE dealer.
- The CDA-9820XM uses female RCA-type jacks for connection to other units (e.g. amplifier) having RCA connectors. You may need an adaptor to connect other units. If so, please contact your authorized ALPINE dealer for assistance.
- Be sure to connect the speaker (-) leads to the speaker (-) terminal. Never connect left and right channel speaker cables to each other or to the vehicle body.

IMPORTANT

Please record the serial number of your unit in the space provided below and keep it as a permanent record. The serial number plate is located on the bottom of the unit.

SERIAL NUMBER: _____
INSTALLATION DATE: _____
INSTALLATION TECHNICIAN: _____
PLACE OF PURCHASE: _____

Installation

Caution

Do not block the unit's fan or heat sink, thus preventing air circulation. If blocked, heat will accumulate inside the unit and may cause a fire.

Air ventilation hole



<Rear side>

1

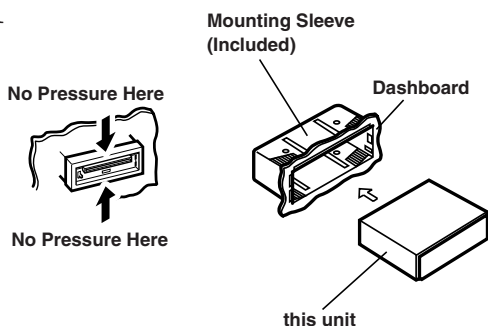

Remove the Detachable Front Panel (page 5). Slide mounting sleeve from main unit. (see "Removal" on this page). Slide the mounting sleeve into the dashboard.

- Please examine the installation. Make certain that no external pressure is applied to either the top of the unit or the removable nosepiece.

2

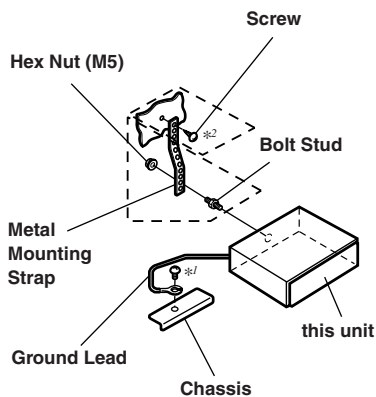

Reinforce the head unit with the metal mounting strap (not supplied). Secure the ground lead of the unit to a clean metal spot using a screw (*) already attached to the vehicle's chassis.

- For the screw marked "*2", use an appropriate screw for the chosen mounting location.

Connect each input lead coming from an amplifier or equalizer to the corresponding output lead coming from the left rear of the CDA-9820XM. Connect all other leads of the CDA-9820XM according to details described in the CONNECTIONS section.

3

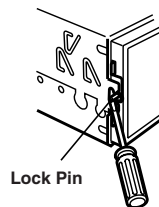

Slide the CDA-9820XM into the dashboard. When the unit is in place, make sure the locking pins are fully seated in the down position. This can be done by pressing firmly in on the unit while pushing the locking pin down with a small screwdriver. This ensures that the unit is properly locked and will not accidentally come out from the dashboard. Install the detachable front panel.

Removal

- 1 Remove the detachable front panel.
- 2 Use a small screwdriver (or similar tool) to push the locking pins to the "up" position (see above drawing). As each pin is unlocked, gently pull out on the unit to make sure it does not re-lock before unlocking the second pin.
- 3 Pull the unit out, keeping it unlocked as you do so.

<JAPANESE CAR>

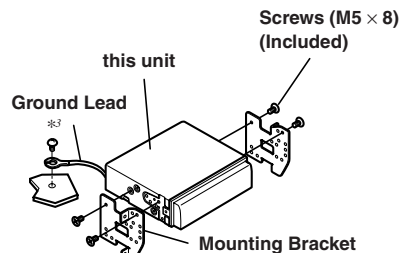
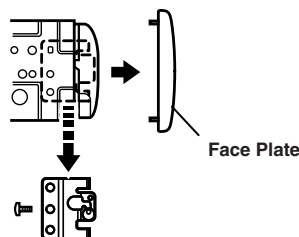

- Secure the ground lead of the unit to a clean metal spot using a screw (*) already attached to the vehicle's chassis.

Connections

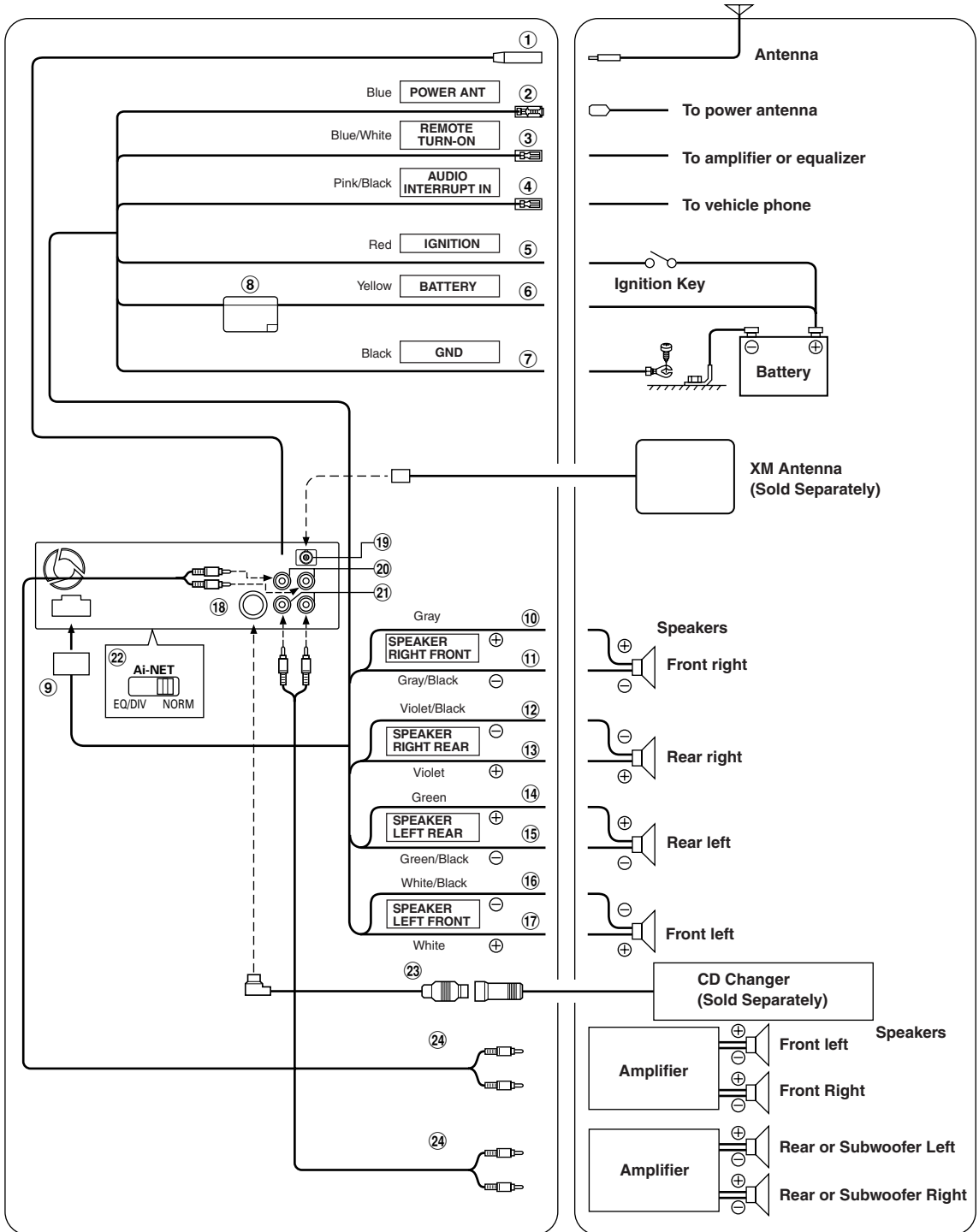

- ① Antenna Receptacle
- ② Power Antenna Lead (Blue)
Connect this lead to the +B terminal of your power antenna, if applicable.
- *This lead should be used only for controlling the vehicle's power antenna. Do not use this lead to turn on an amplifier or a signal processor, etc.*
- ③ Remote Turn-On Lead (Blue/White)
Connect this lead to the remote turn-on lead of your amplifier or signal processor.
- ④ Audio Interrupt In Lead (Pink/Black)
- ⑤ Switched Power Lead (Ignition) (Red)
Connect this lead to an open terminal on the vehicle's fuse box or another unused power source which provides (+)12V only when the ignition is turned on or in the accessory position.
- ⑥ Battery Lead (Yellow)
Connect this lead to the positive (+) post of the vehicle's battery.
- ⑦ Ground Lead (Black)
Connect this lead to a good chassis ground on the vehicle. Make sure the connection is made to bare metal and is securely fastened using the sheet metal screw provided.
- ⑧ Fuse Holder (10A)
- ⑨ Power Supply Connector
- ⑩ Right Front (+) Speaker Output Lead (Gray)
- ⑪ Right Front (-) Speaker Output Lead (Gray/Black)
- ⑫ Right Rear (-) Speaker Output Lead (Violet/Black)
- ⑬ Right Rear (+) Speaker Output Lead (Violet)
- ⑭ Left Rear (+) Speaker Output Lead (Green)
- ⑮ Left Rear (-) Speaker Output Lead (Green/Black)
- ⑯ Left Front (-) Speaker Output Lead (White/Black)
- ⑰ Left Front (+) Speaker Output Lead (White)
- ⑱ Ai-NET Connector
Connect this to the output or input connector of other product (CD Changer, Equalizer, etc.) equipped with Ai-NET.
- *You can input TV/video sound by connecting an optional Ai-NET/RCA Interface cable (KCA-121B) to this component.*
- ⑲ XM Antenna Connector
Connect this to an optional XM antenna.
- ⑳ Front Output RCA Connectors
RED is right and WHITE is left.
- ㉑ Rear/Subwoofer Output RCA Connectors
RED is right and WHITE is left.
- *When Subwoofer is set to OFF: Output is from Rear speakers. When Subwoofer is set to ON: Output is from Subwoofer. For details on how to set the Subwoofer to ON/OFF, see "Subwoofer On and Off" on page 15.*
- ㉒ System Switch
When connecting a processor or divider using Ai-NET, place this switch in the EQ/DIV position. When no device is connected, leave the switch in the NORM position.
- *Be sure to turn the power off to the unit before changing the switch position.*
- ㉓ Ai-NET Cable (Included with CD Changer)
- ㉔ RCA Extension Cable (Sold Separately)

To prevent noise/interference in the audio system.

- Locate the unit and route the leads at least 10 cm away from the car harness.
- Keep the battery power leads as far away from other leads as possible.
- Connect the ground lead securely to a bare metal spot (remove any paint, dirt or grease if necessary) of the car chassis.
- If you add an optional noise suppressor, connect it as far away from the unit as possible. Your Alpine dealer carries various noise suppressors, contact them for further information.
- Your Alpine dealer knows best about noise prevention measures so consult your dealer for further information.

LIMITED WARRANTY

ALPINE ELECTRONICS OF AMERICA, INC. AND ALPINE OF CANADA INC. ("Alpine"), are dedicated to quality craftsmanship and are pleased to offer this Warranty. We suggest that you read it thoroughly. Should you have any questions, please contact your Dealer or Alpine at one of the telephone numbers listed below.

● PRODUCTS COVERED:

This Warranty covers Car Audio/Visual Products and Related Accessories ("the product"). Products purchased in the Canada are covered only in the Canada. Products purchased in the U.S.A. are covered only in the U.S.A.

● LENGTH OF WARRANTY:

This Warranty is in effect for one year from the date of the first consumer purchase.

● LIFETIME TAPE HEAD WARRANTY:

All Alpine Car Audio analog tape heads excluding Video tape heads are warranted for life against manufacturing defects causing failure.

● WHO IS COVERED:

This Warranty only covers the original purchaser of the product, who must reside in the United States, Puerto Rico or Canada.

● WHAT IS COVERED:

This Warranty covers defects in materials or workmanship (parts and labor) in the product.

● WHAT IS NOT COVERED:

This Warranty does not cover the following:

- ① Damage occurring during shipment of the product to Alpine for repair (claims must be presented to the carrier).
- ② Damage caused by accident, abuse, negligence, misuse, improper connections, improper operation or failure to follow instructions contained in the Owner's manual.
- ③ Damage caused by act of God, including without limitation, earthquake, fire, flood, storms or other acts of nature.
- ④ Any cost or expense related to the removal or reinstallation of the product.
- ⑤ Service performed by an unauthorized person, company or association.
- ⑥ Any product which has the serial number defaced, altered or removed.
- ⑦ Any product which has been adjusted, altered or modified without Alpine's consent.
- ⑧ Any product not distributed by Alpine within the United States, Puerto Rico or Canada.
- ⑨ Any product not purchased from an Authorized Alpine Dealer.
- ⑩ Any product that has been determined to contain an excessive amount of dust or dirt and any product that contains other contaminants including liquid or foreign objects.

● HOW TO OBTAIN WARRANTY SERVICE:

- ① You are responsible for delivery of the product to an Authorized Alpine Service Center or Alpine for repair and for payment of any initial shipping charges. Alpine will, at its option, repair or replace the product with a new or reconditioned product without charge. If the repairs are covered by the warranty, and if the product was shipped to an Authorized Alpine Service Center or Alpine, Alpine will pay the return shipping charges.

- ② You should provide a detailed description of the problem(s) for which service is required.

- ③ You must supply proof of your purchase of the product.

- ④ You must package the product securely to avoid damage during shipment.

● HOW WE LIMIT IMPLIED WARRANTIES:

ANY IMPLIED WARRANTIES INCLUDING FITNESS FOR USE AND MERCHANTABILITY ARE LIMITED IN DURATION TO THE PERIOD OF THE EXPRESS WARRANTY SET FORTH ABOVE AND NO PERSON IS AUTHORIZED TO ASSUME FOR ALPINE ANY OTHER LIABILITY IN CONNECTION WITH THE SALE OF THE PRODUCT.

● HOW WE EXCLUDE CERTAIN DAMAGES:

ALPINE EXPRESSLY DISCLAIMS LIABILITY FOR INCIDENTAL AND CONSEQUENTIAL DAMAGES CAUSED BY THE PRODUCT. THE TERM "INCIDENTAL DAMAGES" REFERS TO EXPENSES OF TRANSPORTING THE PRODUCT TO THE ALPINE SERVICE CENTER, LOSS OF THE ORIGINAL PURCHASER'S TIME, LOSS OF THE USE OF THE PRODUCT, BUS FARES, CAR RENTALS OR OTHERS COSTS RELATING TO THE CARE AND CUSTODY OF THE PRODUCT. THE TERM "CONSEQUENTIAL DAMAGES" REFERS TO THE COST OF REPAIRING OR REPLACING OTHER PROPERTY WHICH IS DAMAGED WHEN THIS PRODUCT DOES NOT WORK PROPERLY. THE REMEDIES PROVIDED UNDER THIS WARRANTY ARE EXCLUSIVE AND IN LIEU OF ALL OTHERS.

● HOW STATE/PROVINCIAL LAW RELATES TO THE WARRANTY:

This Warranty gives you specific legal rights, and you may also have other rights which vary from state to state and province to province. In addition, some states/provinces do not allow limitations on how long an implied warranty lasts, and some do not allow the exclusion or limitation of incidental or consequential damages. Accordingly, limitations as to these matters contained herein may not apply to you.

● IN CANADA ONLY:

This Warranty is not valid unless your Alpine car audio product has been installed in your vehicle by an Authorized Installation Center, and this warranty stamped upon installation by the installation center.

● HOW TO CONTACT CUSTOMER SERVICE:

Should the product require service, please call the following number for your nearest Authorized Alpine Service Center.

U.S.A.	1-800-ALPINE-1 (1-800-257-4631)
CANADA	1-800-ALPINE-1 (1-800-257-4631)

Alpine Electronics of America, Inc., 19145 Gramercy Place, Torrance, California 90501, U.S.A.

Alpine Electronics of Canada, Inc., Suite 203, 7300 Warden Ave. Markham, Ontario, L3R 9Z6, Canada